

**FINAL**

**Assessment of Reasonable Progress for Regional Haze  
In MANE-VU Class I Areas**

**Methodology for Source Selection, Evaluation of Control Options, and  
Four Factor Analysis**

*Prepared for:*

Ms. Susan S.G. Wierman  
Executive Director  
Mid-Atlantic Regional Air Management Association, Inc.  
711 W. 40<sup>th</sup> Street, Suite 312  
Baltimore, MD 21211

July 9, 2007

827007G184

*Submitted by:*

 **MACTEC**

MACTEC Federal Programs, Inc.  
5001 South Miami Boulevard, Suite 300  
P.O. Box 12077  
Research Triangle Park, NC 27709  
(919) 941-0333, FAX (919) 941-0234  
aswerner@mactec.com



Arthur S. Werner, Ph.D.  
Senior Principal Engineer

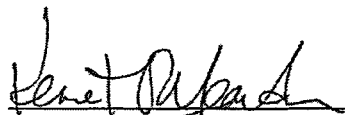

Kenneth R. Mcardon, Ph.D.  
Principal Scientist

**This page left blank intentionally.**

## Table of Contents

<u>Chapter</u>	<u>Page</u>
<b>List of Acronyms .....</b>	<b>v</b>
<b>Executive Summary .....</b>	<b>vii</b>
<b>1 Introduction .....</b>	<b>1-1</b>
Background .....	1-1
Determination of Emission Source Categories and Individual Sources Most Responsible for Regional Haze in MANE-VU Class I Areas .....	1-2
Approach to Demonstrating Reasonable Progress .....	1-6
References .....	1-8
<b>2 Source Category Analysis: Electric Generating Units (EGUs).....</b>	<b>2-1</b>
Source Category Description.....	2-1
Evaluation of Control Options .....	2-2
Four Factor Analysis of Potential Control Scenarios for EGUs .....	2-6
References .....	2-16
<b>3 Analysis of Selected Electric Generating Units (EGUs).....</b>	<b>3-1</b>
EGU Facility Controls.....	3-1
Integrated Planning Model (IPM <sup>®</sup> ) Analysis .....	3-2
Information Obtained from State Agencies.....	3-6
References .....	3-18
EGU Attachment 1 - Illustrative Scrubber Costs (1999 \$) for Representative MW and Heat Rates under the Assumptions in EPA Base Case 2004 .....	3-19
EGU Attachment 2 - Engineering Methodology Used to Calculate \$/ton Pollutant Reduction.....	3-20
<b>4 Source Category Analysis: Industrial, Commercial, and Institutional Boilers.....</b>	<b>4-1</b>
Source Category Description.....	4-1
Evaluation of Control Options .....	4-3
Four Factor Analysis of Potential Control Scenarios for ICI Boilers .....	4-9
References .....	4-15
<b>5 Analysis of Selected Industrial, Commercial, and Institutional Boilers .....</b>	<b>5-1</b>
Source Category Description.....	5-1
Information Obtained from State Agencies.....	5-1
<b>6 Source Category Analysis: Kilns .....</b>	<b>6-1</b>
Source Category Description.....	6-1
Evaluation of SO <sub>2</sub> Emission Control Options .....	6-3
Four Factor Analysis of Potential Control Scenarios for Kilns.....	6-9
References .....	6-13

**Table of Contents – continued**

<b><u>Chapter</u></b>		<b><u>Page</u></b>
<b>7</b>	<b>Analysis of Selected Kilns .....</b>	<b>7-1</b>
	Source Category Description.....	7-1
	Information Obtained from State Agencies.....	7-1
<b>8</b>	<b>Heating Oil.....</b>	<b>8-1</b>
	Background .....	8-1
	Four Factor Analysis of Potential Control Scenarios for Emissions from Heating Oil Combustion .....	8-2
	References .....	8-8
<b>9</b>	<b>Residential Wood Combustion.....</b>	<b>9-1</b>
	Background .....	9-1
	Four Factor Analysis of Potential Control Scenarios for Residential Wood Combustion .....	9-9
	References .....	9-15
<b>10</b>	<b>Residential Wood Combustion – Outdoor Wood Fired Boilers.....</b>	<b>10-1</b>
	Background .....	10-1
	Four Factor Analysis of Potential Control Scenarios for Outdoor Wood-Fired Boilers .....	10-3
	References .....	10-6



**Table of Contents – continued**

<b><u>Table</u></b>	<b><u>Page</u></b>
Table I Summary of Results from the Four Factor Analysis .....	viii
Table 2.1 SO <sub>2</sub> Control Options for Coal-fired EGU Boilers .....	2-3
Table 2.2 Marginal Costs of Emission Reductions (Allowance Prices) Calculated by Integrated Planning Model (IPM <sup>®</sup> ) for the CAIR Base Case and CAIR Plus Runs (2006 \$/ton) ....	2-7
Table 2.3 NO <sub>x</sub> and SO <sub>2</sub> Emissions from the Electric Power Sector (Thousand Tons).....	2-8
Table 2.4 Recent Average Coal Prices from Various Locations in the U.S. (12/2006) (\$/ton) .....	2-9
Table 2.5 Average U.S. Bituminous and Subbituminous Coal Prices (2006 dollars/ton).....	2-9
Table 2.6 Estimated Cost Ranges for SO <sub>2</sub> Control Options for Coal-fired EGU Boilers (2006 dollars/ton of SO <sub>2</sub> Reduced) .....	2-13
Table 3.1 Integrated Planning Model (IPM <sup>®</sup> version 2.1.9) CAIR Plus Results for the Top 30 EGUs Responsible for Visibility Impairment in MANE-VU Class I Areas .....	3-4
Table 3.2 Point Source Information Collected for the Top 30 EGUs Responsible for Visibility Impairment in MANE-VU Class I Areas .....	3-7
Table 3.3 Comparison of Controls Predicted by Integrated Planning Model (IPM <sup>®</sup> ) CAIR Plus Results versus Proposed/Planned Control Additions by the State/Facility (by 2018) at the Top 30 EGUs Responsible for Visibility Impairment in MANE-VU Class I Areas.	3-15
Table 4.1 Available SO <sub>2</sub> Control Options for ICI Boilers .....	4-5
Table 4.2 Potential SO <sub>2</sub> Reductions Through Fuel Switching .....	4-10
Table 4.3 Estimated Dry Sorbent Injection (DSI) Costs for ICI Boilers .....	4-11
Table 4.4 Estimated Flue Gas Desulfurization (FGD) Costs for ICI Boilers (2006 dollars)....	4-12
Table 5.1 Point Source Information Collected from the Top 17 Industrial Facilities Responsible for Visibility Impairment in MANE-VU Class I Areas.....	5-2
Table 6.1 SO <sub>2</sub> Control Technologies for Cement Kilns .....	6-5
Table 6.2 SO <sub>2</sub> Control Costs for AFGD Applied to Dry Kilns and Preheater Kilns (2006 dollars) .....	6-10
Table 6.3 SO <sub>2</sub> Control Costs for Wet FGD Applied to Dry Kilns and Preheater Kilns (2006 dollars) .....	6-10
Table 6.4 SO <sub>2</sub> Control Costs for Dry FGD Applied to Dry Kilns and Preheater Kilns (2006 dollars) .....	6-11
Table 7.1 Point Source Information Collected from the Top 3 Kilns Responsible for Visibility Impairment in MANE-VU Class I Areas .....	7-2
Table 8.1 State Sulfur Limits for Heating Oil.....	8-1
Table 8.2 Ultra Low Sulfur Diesel (ULSD) Desulfurization Technology Costs for Individual Refineries .....	8-2
Table 8.3 Average January 2007 Distillate Stocks (Million Barrels).....	8-5
Table 8.4 Distillate Production and Imports (Million Barrels per Day).....	8-5
Table 9.1 Summary of Measures Available for RWC RACM – PM <sub>10</sub> .....	9-5
Table 9.2 Summary of Measures Available for RWC BACM – PM <sub>10</sub> .....	9-7

**Table of Contents – continued**

<b><u>Table</u></b>	<b><u>Page</u></b>
Table 9.3 Improved Technologies and Fuel Alternatives .....	9-10
Table 9.4 PM Reduction Cost Effectiveness for Replacement of Existing Uncertified Freestanding Cordwood Stove/Insert and Cordwood Fireplace w/o Insert for Heating .....	9-11
Table 9.5 VOC Reduction Cost Effectiveness for Replacement of Existing Uncertified Freestanding Cordwood Stove/Insert and Cordwood Fireplace w/o Insert for Heating .....	9-12
Table 9.6 Reduction Cost Effectiveness for the Replacement of an Existing Centralized Cordwood Heating System.....	9-12
Table 9.7 Pollutant Reduction Cost Effectiveness for the Addition of a Gas Log Set or Use of Wax/Fiber Firelogs in an Existing Fireplace w/o Insert Used for Aesthetics .....	9-13

<b><u>Figure</u></b>	<b><u>Page</u></b>
Figure 1.1 Contributions to PM <sub>2.5</sub> Mass at 7 Sites - 20% Worst Visibility Days (2000-2004).....	1-2
Figure 1.2 MANE-VU 2002 Version 3 Annual Emissions Inventory Top PM <sub>2.5</sub> -Primary Source Categories.....	1-3
Figure 1.3 MANE-VU 2002 Version 3 Annual Emissions Inventory Top SO <sub>2</sub> Source Categories.....	1-4
Figure 3.1 EGU Facilities with the Greatest Visibility Impacts in Mid-Atlantic North Eastern Class I Areas.....	3-2
Figure 6.1 Portland Cement Process Flow Diagram.....	6-1
Figure 6.2 Advanced Flue Gas Desulfurization Process Flow .....	6-7

### List of Acronyms

AFGD	Advanced Flue Gas Desulfurization
BACM	Best Available Control Measure
BART	Best Available Retrofit Technology
BLM	Bureau of Land Management
BTU	British Thermal Unit
CAA	Clean Air Act
CAIR	Clean Air Interstate Rule
CFB	Circulating Fluidized Bed
CHP	Combined Heat and Power
CO <sub>2</sub>	carbon dioxide
DOE	Department of Energy
EGU	Electric Generating Unit
EIA	Energy Information Administration
EPA	Environmental Protection Agency
ESP	Electrostatic Precipitator
FGD	Flue Gas Desulfurization
HAP	Hazardous Air Pollutant
ICI	Industrial, Commercial, Institutional
IPM <sup>®</sup>	Integrated Planning Model
kW	kilowatt
kWh	kilowatt-hour
LADCO	Lake Michigan Air Directors Consortium
LAER	Lowest Achievable Emission Rate
LNB	Low NO <sub>x</sub> Burner
LSD	Lime Spray Drying // Low Sulfur Diesel
LSFO	Limestone Forced Oxidation

### List of Acronyms - continued

MACT	Maximum Achievable Control Technology
MANE-VU	Mid-Atlantic/Northeast Visibility Union
MARAMA	Mid-Atlantic Regional Air Management Association
MEL	Magnesium Enhanced Lime
MM	million
MMBTU	Million British Thermal Units
MRPO	Midwest Regional Planning Organization
MW	Megawatt
NESCAUM	Northeast States for Coordinated Air Use Management
NO <sub>x</sub>	nitrogen oxides
NSPS	New Source Performance Standard
NSR	New Source Review
O&M	Operation and Maintenance
OFA	Over-fire Air
PADD	Petroleum Administration for Defense District
PM	Particulate Matter
PM <sub>10</sub>	Particulate Matter with diameter 10 micrometers or less
PM <sub>2.5</sub>	Particulate Matter with diameter 2.5 micrometers or less
PSD	Prevention of Significant Deterioration
RACM	Reasonably Available Control Measure
RACT	Reasonably Available Control Technology
RWC	Residential Wood Combustion
SACR	Selective Auto-catalytic Reduction
SCC	Source Classification Code
SCR	Selective Catalytic Reduction
SIP	State Implementation Plan
SNCR	Selective Non-catalytic Reduction
SO <sub>2</sub>	sulfur dioxide
SOFA	Separated Over-fire Air
ULSD	Ultra Low Sulfur Diesel

## EXECUTIVE SUMMARY

The Regional Haze regulations set forth under 40 CFR 51.308(d)(1) require States to achieve reasonable progress toward natural visibility conditions. The national visibility goal in Class I areas is defined in the CAA Section 169A(a)(1) as “the prevention of any future, and the remedying of any existing, impairment of visibility...”, and is expected to be satisfied by 2064 with a return to natural visibility conditions. States containing Class I areas must set Reasonable Progress Goals (RPGs) to define future visibility conditions that are expected (but not required) to be equal to, or better, than visibility conditions expected by the uniform rate of progress at any future year until natural conditions are achieved. RPGs are to be established for the final year in the planning period, which in the case of the first SIP is 2018.

Following draft guidance from EPA in establishing RPGs, States must set a baseline from which reasonable progress towards visibility improvement will be measured. The MANE-VU baseline year for the emission inventory is 2002 and for monitoring is 2000-2004. The next task is to identify key pollutants affecting visibility impairment at each Class I area. The major pollutant contributing to visibility impairment in MANE-VU has been shown to be sulfate.

In order to determine the key source regions and source types affecting visibility impairment at each Class I area, a contribution assessment was prepared by NESCAUM for MANE-VU. Major contributors were identified by ranking emissions sources, comparing Q/d (emission impact over distance), and modeling visibility impacts. Source apportionment and other analyses documented in MANE-VU’s contribution assessment showed that several source categories have impacts on visibility at MANE-VU Class I areas.

The largest contribution to visibility impairment at most sites was from burning of coal, primarily utility and industrial combustion sources in MANE-VU and nearby States. At forested rural sites, biogenic organics are a moderate to large contributor to visibility impairment, but other sources of secondary organics also contribute. Wood smoke and ammonium nitrate were identified as small to moderate contributors.

Based on information from the contribution assessment and additional emissions inventory analysis, MANE-VU selected the following source categories for analysis in this project:

- Coal and oil-fired Electric Generating Units, (EGUs);
- Point and area source industrial, commercial and institutional boilers;
- Cement kilns;
- Lime kilns;
- The use of heating oil; and
- Residential wood combustion

This document presents the results of an analysis of the economic and environmental impacts of potential control scenarios that could be implemented by MANE-VU States to reduce emissions from the above source categories in order to make reasonable progress toward meeting visibility improvement goals. The purpose of this analysis is to present information that can be used by States to develop policies and implementation plans to address reasonable progress goals. Control technologies to achieve reasonable progress goals are evaluated with respect to four factors listed in the Clean Air Act (Section 169A):

- Cost,
- Compliance timeframe,
- Energy and non-air quality environmental impacts, and
- Remaining useful life for affected sources.

The “four factor” analysis was applied to control options identified for each of the selected source categories. Cement kilns and lime kilns are analyzed together due to the similarity of the two source categories.

The table below presents a summary of the four factor analysis for the source categories analyzed. Detailed information on control technologies assessed in this effort is presented in the main body of this document.

**Table I Summary of Results from the Four Factor Analysis**

Source Category	Primary Regional Haze Pollutant	Average Cost in 2006 dollars (per ton of pollutant reduction)	Compliance Timeframe	Energy and Non-Air Quality Environmental Impacts	Remaining Useful Life
Electric Generating Units	SO <sub>2</sub>	IPM* v.2.1.9 predicts \$775-\$1,690  \$170-\$5,700 based on available literature	2-3 years following SIP submittal	Fuel supply issues, potential permitting issues, reduction in electricity production capacity, wastewater issues	50 years or more
Industrial, Commercial, Institutional Boilers	SO <sub>2</sub>	\$130-\$11,000 based on available literature	2-3 years following SIP submittal	Fuel supply issues, potential permitting issues, control device energy requirements, wastewater issues	10-30 years
Cement and Lime Kilns	SO <sub>2</sub>	\$1,900-\$73,000 based on available literature	2-3 years following SIP submittal	Control device energy requirements, wastewater issues	10-30 years
Heating Oil	SO <sub>2</sub>	\$550-\$750 based on available literature. There is a high uncertainty associated with this cost estimate.	Currently feasible. Capacity issues may influence timeframe for implementation of new fuel standards	Increases in furnace/boiler efficiency, Decreased furnace/boiler maintenance requirements	18-25 years
Residential Wood Combustion	PM and VOC	\$0-\$10,000 based on available literature	Several years - dependent on mechanism for emission reduction	Reduce greenhouse gas emissions, increase efficiency of combustion device	10-15 years

\* Integrated Planning Model (IPM<sup>®</sup>) application by ICF for MANE-VU

This report also contains information on current and planned controls at 20 specific non-EGU sources and 30 specific EGU sources identified by MANE-VU to consider control strategies already in place or planned by 2018.

## CHAPTER 1

### INTRODUCTION

#### BACKGROUND

The Regional Haze regulations set forth under 40 CFR 51.308(d)(1) require States to achieve reasonable progress toward natural visibility conditions. The national visibility goal in Class I areas is defined in the CAA Section 169A(a)(1) as “the prevention of any future, and the remedying of any existing, impairment of visibility...”, and is expected to be satisfied by 2064 with a return to natural visibility conditions. States containing Class I areas must set Reasonable Progress Goals (RPGs) to define future visibility conditions that are expected (but not required) to be equal to, or better, than visibility conditions expected by the uniform rate of progress at any future year until natural conditions are achieved. RPGs are to be established for the final year in the planning period, which in the case of the first SIP is 2018.

Following draft guidance from EPA in establishing RPGs, States must set a baseline from which reasonable progress towards visibility improvement will be measured. The MANE-VU baseline year for the emission inventory is 2002 and for monitoring is 2000-2004. The next task is to identify key pollutants affecting visibility impairment at each Class I area. The major pollutant contributing to visibility impairment in MANE-VU has been shown to be sulfate.

In addition to the planned reductions that will be included as part of the State SIPs for regional haze, federal programs will also have significant benefits in reducing regional haze by 2018 and beyond. A list of EPA’s national and regional rules as well as voluntary programs that will assist in the reduction of fine particle pollution are as follows:

- Clean Air Interstate Rule (CAIR)
- The Acid Rain Program
- NO<sub>x</sub> SIP Call
- 2004 Clean Air Nonroad Diesel Rule
- 2007 Clean Diesel Trucks and Buses Rule
- Tier 2 Vehicle Emission Standards and Gasoline Sulfur Program
- Emission standards for other engines (highway and non-highway use)
- National Clean Diesel Campaign
- The Great American Woodstove Changeout

More information and links to the programs listed above can be found on the following website:  
<http://www.epa.gov/pm/reducing.html>

## DETERMINATION OF EMISSION SOURCE CATEGORIES AND INDIVIDUAL SOURCES MOST RESPONSIBLE FOR REGIONAL HAZE IN MANE-VU CLASS I AREAS

Particles in the  $PM_{2.5}$  size range are directly responsible for visibility reduction. Figure 1.1 generated by NESCAUM from analysis of monitoring data shows the components of  $PM_{2.5}$  mass at the seven Class I areas of concern on the 20% worst visibility days during the period from 2000-2004. These components of  $PM_{2.5}$  are directly responsible for visibility reduction.

Figure 1.1

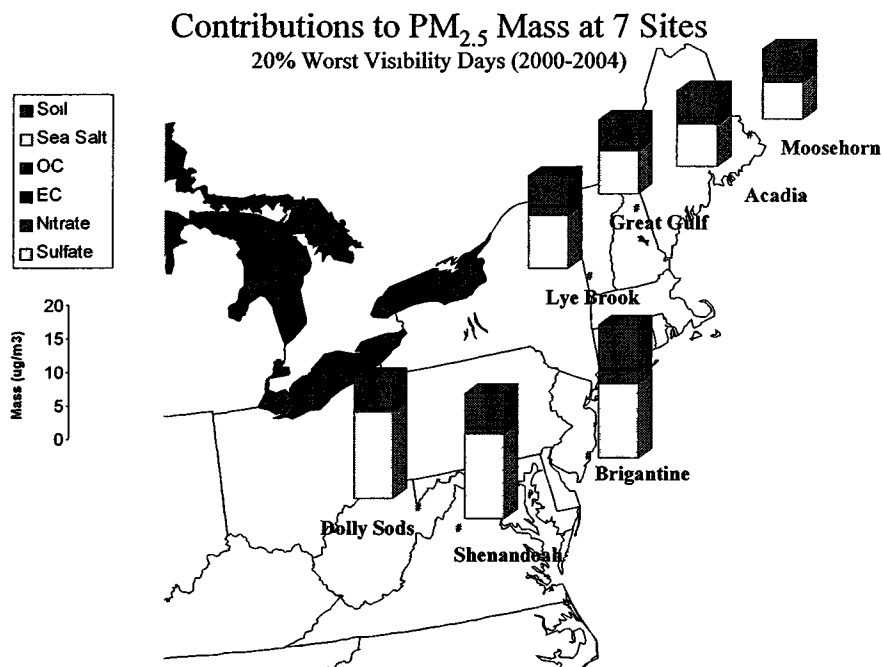

NESCAUM, 2006. "2000-2004 Visibility Rankings and Glide Paths.ppt." PowerPoint Presentation developed by Gary Kleiman.

From Figure 1.1, it is apparent that sulfate is the largest contributor to  $PM_{2.5}$  mass at the Class I areas of concern. The second largest contributor to  $PM_{2.5}$  mass is organic carbon (OC). Nitrates, elemental carbon (EC), soil, and sea salt also contribute to  $PM_{2.5}$  mass.

Source apportionment and other analyses documented in MANE-VU's contribution assessment indicated that a number of source categories have impacts on visibility at MANE-VU Class I areas. The largest contribution to visibility impairment at most sites was  $SO_2$  from coal-combustion, primarily utility and industrial sources in MANE-VU and nearby States. At forested rural sites, biogenic organics are a moderate to large contributor to visibility impairment but other sources of secondary organics also contribute. Wood smoke and ammonium nitrate were identified as small to moderate contributors (see Appendix B of the Contribution Assessment).



The contribution assessment also included an analysis of haze-associated pollutant emissions. “SO<sub>2</sub> is the primary precursor pollutant for sulfate particles. Sulfate particles commonly account for more than fifty percent of particle light extinction at northeastern Class I areas on the clearest days and for as much as or more than eighty percent on the haziest days.” The assessment noted that point sources dominate SO<sub>2</sub> emissions in the MANE-VU region. Point source emissions sources primarily consist of stationary combustion sources for generating electricity, industrial power, and heat. Commercial and residential heating constitute another important source category in MANE-VU States. An analysis of the largest sources in the region also indicates that a few large kilns are among the largest SO<sub>2</sub> sources in the region.

Figures 1.2 and 1.3 show the top emissions source categories of PM<sub>2.5</sub> and SO<sub>2</sub> from Version 3 of the 2002 MANE-VU emissions inventory. The largest SO<sub>2</sub> source categories are the largest contributors to visibility impairment in MANE-VU.

**Figure 1.2 MANE-VU 2002 Version 3 Annual Emissions Inventory  
 Top PM<sub>2.5</sub> Primary Source Categories**

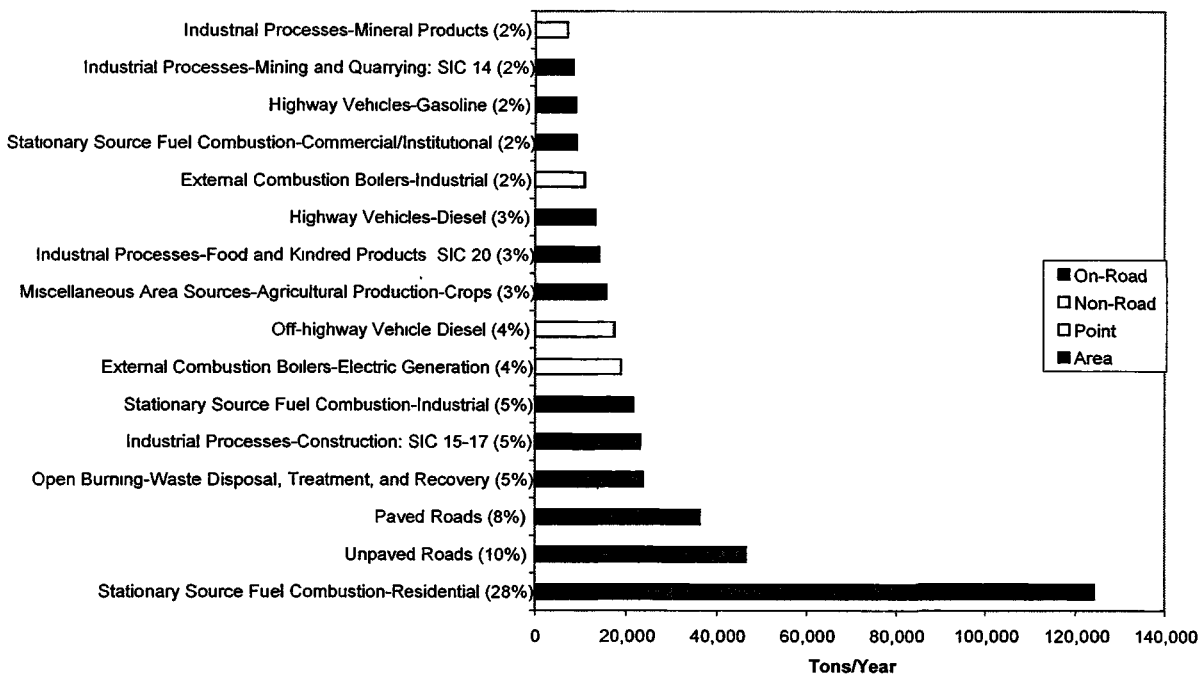

**Figure 1.3 MANE-VU 2002 Version 3 Annual Emissions Inventory  
Top SO<sub>2</sub> Source Categories**

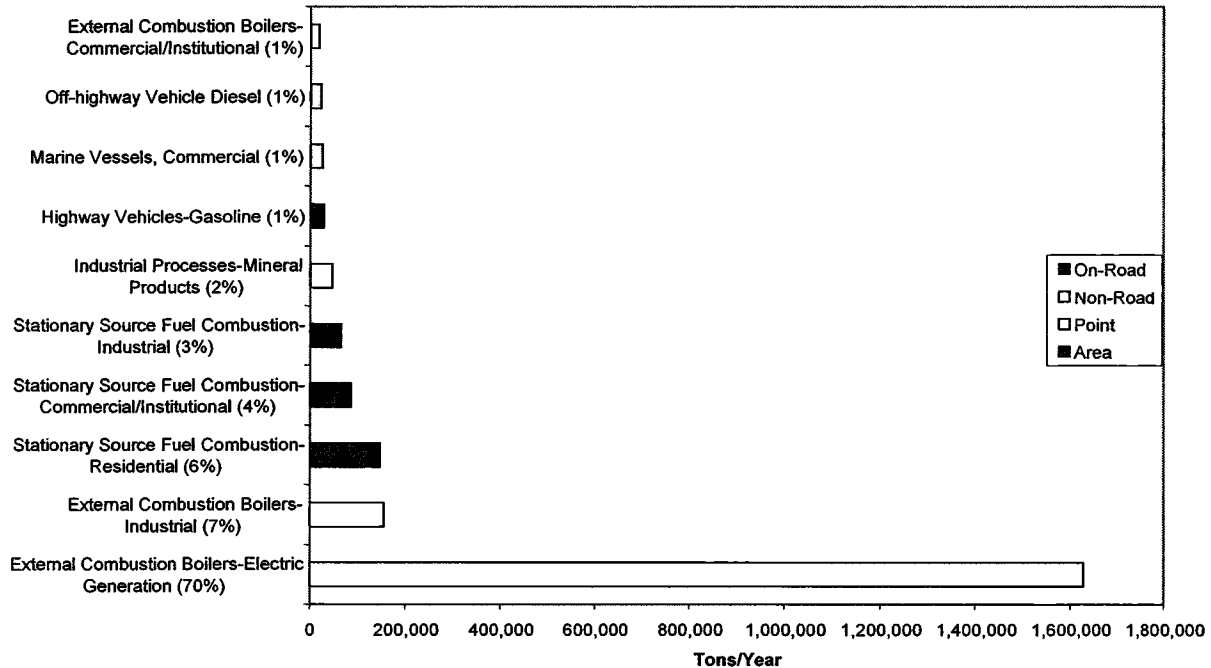

### **Description of Individual Source Identification Process and Modeling**

The following discussion describes the data and procedures that were used to identify the individual sources with the greatest impact on regional haze in MANE-VU Class I areas. The individual sources included in this report (see Chapters 3, 5, and 7) were determined by identifying the sources with the maximum predicted 24-hour sulfate ion impact.

From 2004 to 2006, the Vermont Department of Environmental Conservation (VTDEC) participated in MANE-VU RPO planning activities by performing regional scale screening modeling of pollutants known to contribute to regional haze at Class I areas in the MANE-VU region. The model used by VTDEC was the CALPUFF model run on a domain including most of the eastern United States. Both point and area sources were modeled for the entire year 2002, and variable hourly CEMS emission data were used for all the largest 750+ EGUs in the domain. Model results were primarily intended to be used in conjunction with other source/receptor modeling methods as part of the technical underpinning of the document, *Contributions to Regional Haze in the Northeast and Mid-Atlantic United States: Mid-Atlantic/Northeast Visibility Union (MANE-VU) Contribution Assessment*, prepared by NESCAUM for MANE-VU and dated August 2006. This document contains more detailed discussion of the approach used to develop inputs for the modeling platform, the model setup, and its validation. It can be found at the following link: <http://www.manevu.org/Document.asp?fview=Reports#>

Starting in 2006, through its participation on two MANE-VU RPO workgroups, (the BART Workgroup and the Reasonable Progress Workgroup), which were charged with developing technical support information for regional haze plans for the MANE-VU Class I areas, VTDEC made available some of the EGU source modeling results previously generated during its work on the contribution assessment report cited above. VTDEC also performed new point source modeling with the same CALPUFF modeling platform for a number of additional large point sources identified by the workgroups, primarily non-EGUs. The new point source modeling was performed for sources that did not have CEMS hourly emission data. This new modeling performed specifically for the workgroups differed in this fundamental way from the modeling of large EGUs with available CEMS hourly emission data which had been done for the contribution assessment. All new non-EGU point source modeling performed with CALPUFF by VTDEC for the BART and Reasonable Progress Workgroups utilized a constant average hourly emission rate (annual tons/8760) for the year 2002 based on emissions provided by the individual States in which the sources were located. Except for a more complete set of discrete receptors covering each Class I area, all other inputs and settings of the CALPUFF modeling system, including the NWS Observation-based CALMET created wind-fields, were exactly the same as used in the contribution assessment modeling work.

For the Reasonable Progress Workgroup, VTDEC assembled the results of its earlier individual CEMS-based stack modeling of EGUs into tables which listed the maximum 24-hr (calendar day) sulfate ion impact predicted at any receptor in each Class I area due to the emissions from each individual EGU modeled (more than 750). Because the largest contributing pollutant to visibility impairment in all the MANE-VU Class I areas is the sulfate ion, the Reasonable Progress Workgroup felt that ranking point sources based on this maximum 24-hour impact alone would be an appropriate way to prioritize their relative potential for improving visibility and making reasonable progress at these areas. Once the maximum 24-hr sulfate ion impacts modeled for 2002 were ranked from greatest to smallest by EGU, the top impacting EGUs were identified for each of the Class I areas.

In order to examine and prioritize potentially controllable non-EGU large point sources of SO<sub>2</sub> located both within MANE-VU and external to MANE-VU, the Reasonable Progress Workgroup examined the 2002 NEI based on SIC code selections. Selected stack points for sources selected were modeled individually using the stack parameters and the constant annual average emission rate of SO<sub>2</sub> only. VTDEC converted the annual total tons of SO<sub>2</sub> reported by the state to the NEI for that stack point into an average hourly emission rate and ran the CALPUFF model for the 194 largest points identified in three lists supplied by Delaware. The selection of points to model was based first on a selection of the top 100 emitting points modeled from a group of several hundred ICI boilers (list 1) and Cement and Lime Kilns (list 2) identified by SCC code and extracted from the 2002 NEI database. Later this list of 100 stack emission points to model was expanded by adding the top 94 stack points not previously included in the ICI and kiln lists, but identified by more inclusive selection criteria based on SCC codes (list 3) and ranked by annual SO<sub>2</sub> emissions.

The maximum predicted 24-hour sulfate ion impact from each of the 194 non-EGUs modeled were combined into an ordered table showing the largest impacting non-EGU at top and the least impacting non-EGU at the bottom for each Class I area. A similar ordered table was created

showing the annual average sulfate ion impacts of these 194 non-EGU stack points. The top non-EGUs impacting each Class I area were then selected from the top of each list.

The ranked listings for EGUs represent the EGUs most likely to produce the largest sulfate ion impact at each Class I area on a 24-hour basis. The EGU modeled results were based on variable hourly SO<sub>2</sub> emissions from the CEMS data submitted by the sources themselves. For the EGUs, the modeled stack ID for which the hourly SO<sub>2</sub> emission was reported might be a single electric generating unit or it might be a combination of two or more individual electric generating units operating at a plant and emitting from the same stack. The CALPUFF modeling was done on the emission rate supplied for the particular hour of the year 2002 and did not determine whether that emission was from a single EGU or from a combination of several at a plant. Therefore, to identify which particular unit at a plant reporting multiple units emitting from a single stack is responsible for the specific impact due to that hourly emission, would require more information than was available to VTDEC. The reported impact is from the stack and the distribution among units combined in that stack's CEMs data cannot be determined from the modeling results.

For the non-EGU points modeled, there is a slight probability that emissions modeled may have been only from a particular "process" level in the NEI database structure. There may have been more than one process reported for the same emission point during the year 2002 so that a sum of two or more process annual emissions should be modeled and summed for the entire unit level emission control potential to be identified. The top modeled impacts are simply the top for each area based on the 194 separate stack points modeled with each individual annual average emission rate supplied from one of the three NEI selected listings VTDEC received.

## **APPROACH TO DEMONSTRATING REASONABLE PROGRESS**

Based on the contribution assessment, including modeling and emissions inventory analysis, MANE-VU selected the following source categories for analysis in this project:

- Coal and oil-fired Electric Generating Units, (EGUs);
- Point and area source industrial, commercial and institutional boilers;
- Cement kilns;
- Lime kilns;
- The use of heating oil; and
- Residential wood combustion

This document presents the results of an analysis of the economic and environmental impacts of potential control scenarios that could be implemented by MANE-VU States to demonstrate reasonable progress toward meeting visibility improvement goals. The purpose of this analysis is to present information that can be used by States to develop policies and implementation plans to address reasonable progress goals. Control technologies to achieve reasonable progress goals are evaluated with respect to four factors listed in the Clean Air Act (Section 169A):

- Cost,
- Compliance timeframe,
- Energy and non-air quality environmental impacts, and
- Remaining useful life for affected sources.

The “four factor” analysis is applied to control options identified for the selected source categories. The analysis of cement kilns and lime kilns was combined into one section due to the similarity of the two sources.

Category analyses are presented for electric generating units (EGUs), industrial, commercial, and institutional (ICI) boilers, cement kilns, lime kilns, distillate-oil fired heating units, and residential wood combustion. Only sulfur dioxide (SO<sub>2</sub>) emissions are considered for the first five categories. The SO<sub>2</sub> emitted from sources in these five source categories comprised approximately 90% of all SO<sub>2</sub> emitted from within MANE-VU in 2002. For residential wood combustion, the analysis is presented for particulate matter. PM<sub>2.5</sub> emissions from this source were 28% of the total PM<sub>2.5</sub> emitted from within MANE-VU in 2002. Biomass burning causes both direct emissions of primary particles and emissions of volatile organics which can contribute to the formation of secondary organic carbon particles. Organic carbon is typically the second-largest contributor to regional haze in the MANE-VU region.

For EGUs, ICI boilers, and kilns control options include fuel switching, fuel preparation, *in-situ* modifications, and add-on controls. Because of the similarity in available control options, cement and lime kilns have been combined into one category. For oil-fired heating oil, the only control option considered is reduction in sulfur content in the fuel oil. For residential wood combustion and outdoor wood-fired boilers, we have included descriptions of alternative technologies for replacement and emission reduction.

Additionally, we have assembled current and planned controls for the 20 specific non-EGU and 30 EGU sources based on information from State agencies and Integrated Planning Model (IPM<sup>®</sup>). The purpose of selecting these sources is to find out whether the sources that have the greatest impacts on Class I areas near MANE-VU in 2002 are already controlled or will be controlled by 2018. In many cases, States have supplied a schedule of planned controls for these facilities, which we have included in tabular form in this report. In the case of EGUs, we obtained information from the States and from modeled projections developed using Integrated Planning Model (IPM<sup>®</sup>).

## REFERENCES

NESCAUM, 2006. *2000-2004 Visibility Rankings and Glide Paths.ppt*. PowerPoint Presentation developed by Gary Kleiman.

EPA. Information accessed on the web April 6, 2007. <http://www.epa.gov/pm/reducing.html>

Vermont Air Quality Planning. Personal communications regarding description of the source identification and modeling process from Paul Wishinski (802-241-3862, [paul.wishinski@state.vt.us](mailto:paul.wishinski@state.vt.us)) via E-mail on April 4, 2007.

NESCAUM, 2006. *Contributions to Regional Haze in the Northeast and Mid-Atlantic United States*. Prepared by NESCAUM for MANE-VU, August, 2006.

## CHAPTER 2

### SOURCE CATEGORY ANALYSIS: ELECTRIC GENERATING UNITS (EGUs)

#### SOURCE CATEGORY DESCRIPTION

The MANE-VU contribution assessment demonstrated that the principal contributor to visibility impairment in Class I MANE-VU areas and Class I areas affected by emissions from sources within MANE-VU is SO<sub>2</sub> from EGUs. Roughly 70% of the 2.3 million tons of SO<sub>2</sub> emissions in the 2002 emissions inventory (2002 MANE-VU Emissions Inventory Version 3) were from EGUs, making them the largest source category contributing to regional haze in terms of total visibility impairing emissions and in terms of number of facilities.

Boilers at EGUs burn various fuels to produce heat for steam production which is then used to drive turbine generators for electricity production. The primary fuel combusted in EGU boilers in the eastern United States is coal from mines in the Midwest and Appalachia. Coal from this region generally contains 2-4% sulfur. The sulfur contained in the coal is emitted as SO<sub>2</sub> from the boiler. Coal obtained from western States is generally lower in sulfur, with a sulfur content of <1%.

Nationally, 90% of the SO<sub>2</sub> emissions from the EGUs are from coal-fired electric utility boilers. These coal-fired utility boilers are also the largest sources of NO<sub>x</sub> and PM emissions, which also contribute to regional haze. All coal-fired electric utility power plants in the United States use control devices to reduce PM emissions. Additionally, many of the boilers are required to use controls for SO<sub>2</sub> or NO<sub>x</sub> emissions depending on site-specific factors such as the properties of the coal burned, when the power plant was built, and the area where the power plant is located. According to the EPA Clean Air Markets Division, (Personal communication with Mr. Peter Kokopeli, EPA – CAMD on April 3, 2007), as of January 1, 2006, the percentage of coal-fired EGU capacity in the United States with SO<sub>2</sub> and/or NO<sub>x</sub> control devices (as a percentage of heat input), were as follows:

- 2% of coal-fired EGU capacity had SO<sub>2</sub> control only;
- 57% of coal-fired EGU capacity had NO<sub>x</sub> control only;
- 32% of coal-fired EGU capacity had SO<sub>2</sub> and NO<sub>x</sub> controls;
- 9% of coal-fired EGU capacity had no SO<sub>2</sub> or NO<sub>x</sub> controls.

As 66% of coal-fired EGU capacity, (as a percentage of heat input), have no SO<sub>2</sub> controls, there is room for significant reductions in emissions of SO<sub>2</sub>. There is currently a trend towards improving control of SO<sub>2</sub> through installation of additional controls and making other process and fuel changes. The four factor analysis of potential control scenarios for EGUs contained in this chapter addresses the control options and costs, time requirements, energy and non-air impacts, and source life associated with these controls.

Although PM and NO<sub>x</sub> from coal-fired utility boilers contribute to regional haze, the MANE-VU contribution assessment conducted by NESCAUM determined that SO<sub>2</sub> from power plants was the largest contributor to regional haze in the MANE-VU Class I areas. Therefore, the focus of this control option analysis for coal-fired boilers is on SO<sub>2</sub> controls. Effects of the SO<sub>2</sub> control

options on PM and NO<sub>x</sub> emissions are addressed where applicable, to ensure that the impact on emissions of these pollutants is considered for planning purposes.

In addition to coal combustion, some EGUs in MANE-VU States also burn fuel oil and/or natural gas. However, the EGU sources with the greatest impact on MANE-VU Class I areas were all coal-fired units. Emissions of SO<sub>2</sub> from natural gas combustion are negligible, but SO<sub>2</sub> emissions from fuel oil combustion are directly proportional to the sulfur content of the fuel. The cost of switching from a high sulfur distillate fuel oil to a lower sulfur distillate fuel oil is addressed in Chapter 8 of this report.

The SCCs applicable to coal-fired utility boilers include SCCs beginning 1-01-001-XX, 1-01-002-XX, and 1-01-003-XX.

## **EVALUATION OF CONTROL OPTIONS**

Effective post-combustion SO<sub>2</sub> controls for EGUs and particularly coal-fired boilers are well understood and have been applied to a large number of sources over the years in response to regulations in the form of NSPS, PSD/NSR, State RACT Rules and the Title IV Acid Rain Program. Additional SO<sub>2</sub> reductions are anticipated as a result of the Clean Air Interstate Rule (CAIR), which was finalized on May 12, 2005.

In addition to post-combustion controls that can be applied to reduce emissions of SO<sub>2</sub> from coal-fired boilers, there are other strategies that can be used to reduce emissions of SO<sub>2</sub>. Examples of such strategies include switching to a fuel with a lower sulfur content, and coal cleaning prior to combustion. Methods of SO<sub>2</sub> control applicable to coal-fired boilers are listed in Table 2.1 with a brief description of the control option, applicability, and range of performance. A more detailed description of the control option and an analysis of the four factor assessment for reasonable progress follow the table.

MACTEC assembled the list of available SO<sub>2</sub> control options for the EGU source category given in Table 2.1 from available documentation. Note that the estimated performance of each control option varies greatly and depends on a variety of site specific factors, including the boiler type. Examples of three major types of coal-fired boiler include fluidized bed combustors, stoker boilers, and pulverized coal boilers. In addition to these three types of coal-fired boilers there are many subcategories of boilers, characterized by their specific design. Control devices designed for these types of boilers vary in terms of cost as well as estimated performance.



**Table 2.1 SO<sub>2</sub> Control Options for Coal-fired EGU Boilers**

Technology	Description	Applicability	Performance
Switch to a Low Sulfur Coal (generally <1% sulfur)	Replace high-sulfur bituminous coal combustion with lower-sulfur coal	Potential control measure for all coal-fired EGUs currently using coal with high sulfur content	50-80% reduction in SO <sub>2</sub> emissions by switching to a lower-sulfur coal
Switch to natural gas (virtually 0% sulfur)	Replace coal combustion with natural gas	Potential control measure for all coal-fired EGUs	Virtually eliminate SO <sub>2</sub> emissions by switching to natural gas
Coal Cleaning	Coal is washed to remove some of the sulfur and ash prior to combustion	Potential control measure for all coal-fired EGUs	20-25% reduction in SO <sub>2</sub> emissions
Flue Gas Desulfurization (FGD) - Wet	SO <sub>2</sub> is removed from flue gas by dissolving it in a lime or limestone slurry. (Other alkaline chemicals are sometimes used)	Applicable to all coal-fired EGUs	30-95%+ reduction in SO <sub>2</sub> emissions
Flue Gas Desulfurization (FGD) - Spray Dry	A fine mist containing lime or other suitable sorbent is injected directly into flue gas	Applicable primarily for boilers currently firing low to medium sulfur fuels	60-95%+ reduction in SO <sub>2</sub> emissions
Flue Gas Desulfurization (FGD) -Dry	Powdered lime or other suitable sorbent is injected directly into flue gas	Applicable primarily for boilers currently firing low to medium sulfur fuels	40-60% reduction in SO <sub>2</sub> emissions

Table references:

1. *Assessment of Control Technology Options for BART-Eligible Sources*, NESCAUM, March 2005.
2. *Controlling Fine Particulate Matter Under the Clean Air Act A Menu of Options*, STAPPA-ALAPCO, March 2006.

### **Switch to Low Sulfur Coal**

Fuel switching encompasses several different control options. Often it is not possible to completely switch from one type of fuel to another. One option is blending lower-polluting fuels with baseline fuels to reduce overall emissions. For example, many coal-fired boiler operators blend lower sulfur subbituminous coals with high sulfur bituminous coals to reduce SO<sub>2</sub> emissions. In other cases, bituminous coals with a lower sulfur content can be substituted for high sulfur bituminous coal.

The feasibility of fuel switching depends partly on the characteristics of the plant and the particular type of fuel change being considered. Many plants will be able to switch from high-sulfur to low-sulfur bituminous coal without serious difficulty, but switching from bituminous to subbituminous coal may present greater challenges and costs. In some instances, fuel switching will require significant investment and modifications to an existing plant. Switching to a lower sulfur coal can affect coal handling systems, boiler performance, PM control effectiveness and ash handling systems. In any case, fuel switching or blending has been

a key strategy used by EGUs to comply with the federal Acid Rain Program. Overall SO<sub>2</sub> reductions estimated from switching to low-sulfur coal range from 50-80%.

### **Switch to Natural Gas**

Switching from coal combustion to natural gas combustion virtually eliminates SO<sub>2</sub> emissions, but it is currently uneconomical to consider this option for base load EGUs due to the fuel quantity necessary and the price of natural gas. The price of natural gas and coal are variable, but in terms of heating value, the price of natural gas over the past several years has been several times higher than coal. According to information published on the EIA website, in January 2007 the price of natural gas was approximately four times higher than coal according to average monthly costs of fuel delivered to electricity producers during that month.

### **Coal Cleaning**

According to the 2006 STAPPA-ALAPCO document on control technologies titled *Controlling Particulate Matter Under the Clean Air Act: A Menu of Options*, coal cleaning or washing is a widely practiced method of reducing impurities in coal, particularly sulfur. Reducing the sulfur content of the fuel used in the boiler reduces the SO<sub>2</sub> emissions proportionally. Coal cleaning has been shown to reduce SO<sub>2</sub> emissions by 20-25%, while increasing the heating value of the fuel. Additional removal can be achieved through advanced chemical washing techniques, but no detailed information on these techniques was available.

Conventional (physical) coal washing techniques remove ash and sulfur from coal by crushing the fuel and separating the components in a liquid bath, such as water. The lighter coal particles float to the top of the bath for recovery, while the heavier impurities sink to the bottom for removal.

Coal sulfur exists in two forms, inorganic and organic. The inorganic sulfur in coal called pyrite is primarily in the form of ferrous sulfate (FeSO<sub>4</sub>). Because it is not chemically bound within the coal, 40-50% of this pyrite can be removed through coal washing. The organic form of sulfur is chemically bound in the molecular structure of the coal itself and cannot be physically washed out. Organic sulfur accounts for between 35-75% of the total sulfur in Illinois Basin coals in the example given by STAPPA-ALAPCO. Depending on the percentage of the sulfur in a given coal sample which exists in the form of pyrite, varying amounts of the total sulfur can be removed.

Although there are benefits associated with coal washing, there are limitations associated with this technology. The 20-25% SO<sub>2</sub> reduction is beneficial, but post-combustion controls have been shown to reduce SO<sub>2</sub> emissions by greater percentages. Also, solid and liquid wastes are generated using the washing process and must be addressed.

### **Flue Gas Desulfurization (FGD) - Wet**

There are three types of FGD scrubbers: wet, spray dry, and dry. According to the 2006 STAPPA-ALAPCO document on control technologies titled *Controlling Particulate Matter Under the Clean Air Act: A Menu of Options*, EPA reports that 85% of the FGD systems in the

United States are wet systems. Twelve percent of the FGD systems are spray dry systems, and 3% are dry systems. The operating parameters, impacts on capacity factor, and costs of each SO<sub>2</sub> removal method are different. Capacity factor is the amount of energy a facility generates in one year divided by the total amount it could generate if it ran at full capacity.

SO<sub>2</sub> in the flue gas can be removed by reacting the sulfur compounds with a solution of water and an alkaline chemical to form insoluble salts that are removed in the scrubber effluent. These processes are called "wet FGD systems". Most wet FGD systems are based on using either limestone or lime as the alkaline source. At some of these facilities, fly ash is mixed with the limestone or lime. Several other scrubber system designs (e.g., sodium carbonate, magnesium oxide, dual alkali) are used by a small percentage of the total number of boilers.

The basic wet limestone scrubbing process is simple and is the type most widely used for control of SO<sub>2</sub> emissions from coal-fired electric utility boilers. Limestone sorbent is inexpensive and generally available throughout the United States. In a wet limestone scrubber, the flue gas containing SO<sub>2</sub> is brought into contact with limestone/water slurry. The SO<sub>2</sub> is absorbed into the slurry and reacts with limestone to form an insoluble sludge. The sludge, mostly calcium sulfite hemihydrate and gypsum, is disposed of in a pond specifically constructed for the purpose or is recovered as a salable byproduct. Integrated Planning Model (IPM<sup>®</sup>) used by EPA to predict future EGU control strategies assumes that this technology will be used to control SO<sub>2</sub> from coal-fired boilers that are 100 MW or larger, that combust bituminous coal with 2% or higher sulfur content by weight. Integrated Planning Model (IPM<sup>®</sup>) documentation refers to the specific scrubber technology as Limestone Forced Oxidation, (LSFO), and assumes 95% SO<sub>2</sub> removal using this technology. Data and documentation obtained for use in this report are from Integrated Planning Model (IPM<sup>®</sup>) version 2.1.9.

The wet lime scrubber operates in a similar manner to the wet limestone scrubber. In a wet lime scrubber, flue gas containing SO<sub>2</sub> is contacted with hydrated lime/water slurry; the SO<sub>2</sub> is absorbed into the slurry and reacts with hydrated lime to form an insoluble sludge. The hydrated lime provides greater alkalinity (higher pH) and reactivity than limestone. However, lime-scrubbing processes require disposal of large quantities of waste sludge.

Another wet scrubber technology used to control emissions of SO<sub>2</sub> from EGUs is Magnesium Enhanced Lime, (MEL). This technology is available to coal-fired boilers from 100 MW to 550 MW in capacity, that combust bituminous, sub-bituminous or lignite coal with less than 2.5% sulfur content by weight. Integrated Planning Model (IPM<sup>®</sup>) assumes that MEL provides 96% SO<sub>2</sub> removal.

The SO<sub>2</sub> removal efficiencies of existing wet limestone scrubbers range from 31-97%, with an average of 78%. The SO<sub>2</sub> removal efficiencies of existing wet lime scrubbers range from 30 to 95%. For both types of wet scrubbers, operating parameters affecting SO<sub>2</sub> removal efficiency include liquid-to-gas ratio, pH of the scrubbing medium, and the ratio of calcium sorbent to SO<sub>2</sub>. Periodic maintenance is needed because of scaling, erosion, and plugging problems. Recent advancements include the use of additives or design changes to promote SO<sub>2</sub> absorption or to reduce scaling and precipitation problems.

### **Flue Gas Desulfurization (FGD) – Spray Dry**

A spray dryer absorber (sometimes referred to as wet-dry or semi-dry scrubber) operates by the same principle as wet lime scrubbing, except that the flue gas is contacted with a fine mist of lime slurry instead of a bulk liquid (as in wet scrubbing). For the spray dryer absorber process, the combustion gas containing SO<sub>2</sub> is contacted with fine spray droplets of hydrated lime slurry in a spray dryer vessel. This vessel is located downstream of the air heater outlet where the gas temperatures are in the range of 120 to 180 °C (250 to 350 °F). The SO<sub>2</sub> is absorbed in the slurry and reacts with the hydrated lime reagent to form solid calcium sulfite and calcium sulfate sludge as in a wet lime scrubber. The water is evaporated by the hot flue gas and forms dry, solid particles containing the reacted sulfur. These particles are entrained in the flue gas, along with fly ash, and are collected in a PM collection device. Most of the SO<sub>2</sub> removal occurs in the spray dryer vessel itself, although some additional SO<sub>2</sub> capture has also been observed in downstream particulate collection devices, especially fabric filters. This process produces dry reaction waste products for easy disposal.

The primary operating parameters affecting SO<sub>2</sub> removal are the calcium-reagent-to-sulfur stoichiometric ratio and the approach to saturation in the spray dryer. To increase overall sorbent use, the solids collected in the spray dryer and the PM collection device may be recycled. The SO<sub>2</sub> removal efficiencies of existing lime spray dryer systems range from 60-95%.

Lime Spray Drying (LSD) is a dry SO<sub>2</sub> scrubber technology applied in Integrated Planning Model (IPM<sup>®</sup>) runs for coal-fired boilers 550 MW or larger that combust bituminous, subbituminous or lignite coal with sulfur content between 0.4% and 2% sulfur by weight. Integrated Planning Model (IPM<sup>®</sup>) assumes that LSD provides 90% SO<sub>2</sub> removal.

### **Flue Gas Desulfurization (FGD) –Dry**

For the dry injection process, dry powdered lime (or another suitable sorbent) is directly injected into the ductwork upstream of a PM control device. Some systems use spray humidification followed by dry injection. This dry process eliminates the slurry production and handling equipment required for wet scrubbers and spray dryers, and produces dry reaction waste products for easier disposal. The SO<sub>2</sub> is adsorbed and reacts with the powdered sorbent. The dry solids are entrained in the combustion gas stream, along with fly ash, and collected by the PM control device. The SO<sub>2</sub> removal efficiencies of existing dry injection systems range from 40-60%.

## **FOUR FACTOR ANALYSIS OF POTENTIAL CONTROL SCENARIOS FOR EGUs**

Each of the control options presented in Table 2.1 is evaluated in this section according to the four factors for determining reasonable progress as required by Section 169A(g)(1) of the Clean Air Act and 40 CFR 51.308(d)(1)(i)(A). The information provided in this section is intended to be used by the States in setting Reasonable Progress Goals for reducing regional haze in the MANE-VU Class I areas.

**Cost of Compliance**

For EGUs, EPA used Integrated Planning Model (IPM<sup>®</sup>) to predict which units will install controls at what costs and which units will buy credits. Integrated Planning Model (IPM<sup>®</sup>) predicts a least-cost solution to meet power production demands within emissions constraints. Emissions may be reduced by fuel-switching, use of controls or by using power from a cleaner unit. The RPOs made some Integrated Planning Model (IPM<sup>®</sup>) runs to determine which units will install controls to comply with the EPA CAIR rule. Additionally, MANE-VU investigated an even more stringent “CAIR Plus” strategy using Integrated Planning Model (IPM<sup>®</sup>). In Chapter 3, the parsed results (projections disaggregated to the unit level), available for the CAIR Plus strategy are used to help estimate costs for specific EGUs. It should be noted that Integrated Planning Model (IPM<sup>®</sup>) is an industry-wide model, and the control costs output from the model represent the industry-wide average cost of control that can be expected based on a set industry-wide emission reduction. Integrated Planning Model (IPM<sup>®</sup>) results can also be viewed as the predicted cost of control at a model plant. The costs of control at individual facilities are dependent on a number of factors and cannot be determined for any specific individual facility from Integrated Planning Model (IPM<sup>®</sup>) results.

Table 2.2 contains the marginal costs of SO<sub>2</sub> emission reductions, also known as the SO<sub>2</sub> allowance price, for MANE-VU Base Case CAIR, (MARAMA\_5c), and CAIR Plus, (MARAMA 4c), Integrated Planning Model (IPM<sup>®</sup>) runs. These costs include the capital costs of new investments, fuel costs, and the operation and maintenance costs of power plants. For both the CAIR and CAIR Plus run, Integrated Planning Model (IPM<sup>®</sup>) installed scrubbers to meet the demand for SO<sub>2</sub> reduction while meeting the demand for electricity. Integrated Planning Model (IPM<sup>®</sup>) also installed NO<sub>x</sub> controls, but the cost of achieving the NO<sub>x</sub> emissions reductions was provided independently from SO<sub>2</sub> controls. Application of SO<sub>2</sub> controls such as use of cleaner and lower-sulfur coals or post combustion controls such as wet scrubbers generally help to reduce PM emissions in addition to SO<sub>2</sub>. SO<sub>2</sub> controls generally do not affect PM or NO<sub>x</sub> emissions.

**Table 2.2 Marginal Costs of Emission Reductions (Allowance Prices) Calculated by Integrated Planning Model (IPM<sup>®</sup>) for the CAIR Base Case and CAIR Plus Runs (2006 \$/ton)**

Pollutant	CAIR Base Case (MARAMA_5c)						CAIR Plus Policy Case (MARAMA_4c)					
	2008	2009	2010	2012	2015	2018	2008	2009	2010	2012	2015	2018
SO <sub>2</sub>	774	837	905	979	1,141	1,338	975	1,055	1,139	1,233	1,437	1,684

Table reference:

*Final Draft Report - Comparison of CAIR and CAIR Plus Proposal Using the Integrated Planning Model (IPM<sup>®</sup>), ICF Resources; May 30, 2007.*

Note – A conversion factor of 1.2101 was used to convert the dollar values from 1999 to 2006

[www.inflationdata.com](http://www.inflationdata.com)

The CAIR Plus strategy requires additional SO<sub>2</sub> and NO<sub>x</sub> control beyond EPA’s CAIR program. ICF’s report on the CAIR and CAIR Plus Integrated Planning Model (IPM<sup>®</sup>) runs titled: *Final Draft Report - Comparison of CAIR and CAIR Plus Proposal Using the Integrated Planning*

*Model (IPM<sup>®</sup>)*, states that the power sector opts for a technology strategy for complying with the CAIR Plus proposal requirements. In the CAIR Plus analysis, the CAIR Plus region requires the installation of an additional 19.5 GW of scrubbers and 77.8 GW of SCR by 2012. These controls represent a 30% increase in scrubbers and 185% increase in SCRs in 2012 compared to the Integrated Planning Model (IPM<sup>®</sup>) CAIR run. By 2018, the cumulative installation of scrubbers is 17% higher and the installation of SCR is 98% higher for the CAIR Plus run compared to the CAIR run. The resulting SO<sub>2</sub> and NO<sub>x</sub> emissions from the CAIR and CAIR Plus Integrated Planning Model (IPM<sup>®</sup>) runs are listed for MANE-VU in Table 2.3.

**Table 2.3 NO<sub>x</sub> and SO<sub>2</sub> Emissions from the Electric Power Sector  
 (Thousand Tons)**

	2008	2009	2010	2012	2015	2018
	SO <sub>2</sub>   NO <sub>x</sub>	SO <sub>2</sub>   NO <sub>x</sub>	SO <sub>2</sub>   NO <sub>x</sub>	SO <sub>2</sub>   NO <sub>x</sub>	SO <sub>2</sub>   NO <sub>x</sub>	SO <sub>2</sub>   NO <sub>x</sub>
CAIR Base Case (MARAMA_5c)	802   386	650   272	518   213	463   209	410   202	394   199
CAIR Plus Policy Case (MARAMA_4c)	735   376	556   228	396   159	376   162	312   153	271   146

Table reference:

*Final Draft Report - Comparison of CAIR and CAIR Plus Proposal Using the Integrated Planning Model (IPM<sup>®</sup>)*, ICF Resources; May 30, 2007.

### Cost of Switching to Low Sulfur Coal

Switching to a low-sulfur coal or blending a lower sulfur coal can impact cost due to the following two main reasons:

1. The cost of low-sulfur coal compared to higher sulfur coal
2. The cost of necessary boiler or coal handling equipment modifications

The cost of low-sulfur coal compared to higher sulfur coal is not only related to the “dollar per ton” cost of the coal, but also related to the heating value of the coal.

Recent data from the Energy Information Administration show the average price of coals from various locations together with estimated heating values and sulfur content. The prices of coal indicated in Tables 2.4 and 2.5 do not include the cost of delivery.

The energy-based cost of each of the coals listed in Table 2.4 is approximately the same, with the exception of coal from the Powder River Basin. Powder River Basin coal has a significantly lower heating value than the other four varieties of coal, but on an energy basis, it is still approximately one third the cost of the other coals listed. Since Powder River Basin coal contains significantly less sulfur, it would seem that this coal would be the best fuel for boilers trying to incorporate a lower sulfur coal. Unfortunately, due to the lower heating value of the coal, boilers that are configured to burn coal with a higher heating value can only use a small percentage of this low-sulfur coal (no higher than 15% Powder River Basin coal). The only way to burn higher percentages of the Powder River Basin coal would be to extensively retrofit the boilers or suffer from poor boiler performance and other operating difficulties. Such retrofits should be reviewed in light of current Prevention of Significant Deterioration (PSD) permitting

regulations to ensure that all such requirements are met and that emissions do not increase. The coal prices included in Table 2.4 do not reflect the cost of boiler retrofits required to combust low sulfur coal.

**Table 2.4 Recent Average Coal Prices from Various Locations in the U.S. (12/2006)**  
 (\$/ton)

	Central Appalachia (Bituminous)	Northern Appalachia (Bituminous)	Illinois Basin (Bituminous)	Powder River Basin (Subbituminous)	Uinta Basin (Low-S Bituminous)
Coal Heating Value (BTU/lb)	12,500	13,000	11,000	8,800	11,700
Sulfur Content (%)	1.2	<3	5	0.8	0.8
Cost/ton (\$)	\$47.25	\$43.00	\$33.33	\$9.85	\$36.00

Table reference:

EIA website accessed on 2/20/07: <http://www.eia.doe.gov/cneaf/coal/page/coalnews/coalmar.html>

The two types of coal used for fuel in EGU boilers in the United States are bituminous and subbituminous coals. Bituminous coals have varying amounts of sulfur, but the sulfur content of bituminous coal is generally higher than subbituminous coal. Traditionally, many EGU boilers have been designed to combust bituminous coal because of the higher carbon content and heating value.

Table 2.5 shows the average 2005 cost data from the Energy Information Administration for bituminous and subbituminous coal. The purpose of this information is to demonstrate the difference in cost of these coals based on their heating value. Assuming a heat content for bituminous coal of 12,000 BTU/lb and 10,000 BTU/lb for subbituminous coal allows the calculation of the cost of the coal on an energy basis. The coal prices included in Table 2.5 do not reflect the cost of boiler retrofits required to combust low sulfur coal.

**Table 2.5 Average U.S. Bituminous and Subbituminous Coal Prices**  
 (2006 dollars/ton)

Fuel	Average Price per Ton	Average Price per MMBTU
Bituminous Coal	\$38.00	\$1.58
Subbituminous Coal	\$8.96	\$0.44

Table reference:

EIA website accessed on 2/20/07: <http://www.eia.doe.gov/cneaf/coal/page/acr/table31.html>

Note – A conversion factor of 1.0323 was used to convert the dollar values from 2005 to 2006  
[www.inflationdata.com](http://www.inflationdata.com)

Switching to subbituminous coal can reduce SO<sub>2</sub> emissions by up to 80%, but changes must be made to the boilers to compensate for the lower heating value of the subbituminous coal. Much of the difference in fuel price is due to the difficulty in using subbituminous coal in boilers

designed to combust bituminous coal. The 2006 STAPPA-ALAPCO document, *Controlling Fine Particulate Matter Under the Clean Air Act*, states that “fuel substitution is not feasible for sources where the substitution would require excessive retrofits or would entail substantial performance losses.”

### Cost of Coal Cleaning

The World Bank reports that the cost of physically cleaning coal varies from \$1 to \$10 per ton of coal cleaned, depending on the coal quality, the cleaning process used, and the degree of cleaning desired. In most cases the costs were found to be between \$1 and \$5 per ton of coal cleaned. Based on the recent prices of coal from Tables 2.4 and 2.5, this cost represents a 2-15% increase in the cost of coal.

In addition to lowering the emissions from coal combustion, coal cleaning also increases the heating value of the fuel. This lowers the transportation cost of the fuel per unit of energy, offsetting the costs associated with the coal washing. It is not clear whether this has been taken into account in the cost information provided by the World Bank.

### Cost of Flue Gas Desulfurization (FGD) – Wet

The cost of flue gas desulfurization varies depending on a number of factors including the size of the boiler, SO<sub>2</sub> reduction requirements, boiler capacity factor, and fuel sulfur content. Taking these factors into account, the typical cost effectiveness of a 1,000 MMBTU/hr (~300MW) coal-fired boiler equipped with wet FGD is around \$410 per ton of SO<sub>2</sub> reduced when combusting high-sulfur coal. This cost is based on a boiler capacity factor of 83% and SO<sub>2</sub> removal efficiency of 90%. Assuming the same boiler and SO<sub>2</sub> control efficiency, but firing low-sulfur coal, the cost per ton is slightly more expensive at \$510 per ton of SO<sub>2</sub> controlled. (*Controlling Fine Particulate Matter Under the Clean Air Act: A Menu of Options*, STAPPA-ALAPCO, March 2006) (Converted from 2003 to 2006 dollars using a conversion factor of 1.0959 [www.inflationdata.com](http://www.inflationdata.com))

A similar cost estimation from the same STAPPA-ALAPCO document provides information for boilers in the size range of >4,000 MMBTU/hr (~1,200 MW) and <4,000 MMBTU/hr achieving >90% SO<sub>2</sub> removal efficiency. These cost estimates demonstrate the initial and ongoing costs of installing wet scrubbers. For units >1,200 MW, the capital costs are between \$380-\$850/MW; operation and maintenance costs (O&M) range from \$7-\$27/MW; and the ultimate cost effectiveness is shown to be from \$230-\$570/ton SO<sub>2</sub> removed. For boilers <1,200 MW, the capital costs are between \$850-\$5,100/MW; operation and maintenance costs (O&M) range from \$28-\$68/MW; and the ultimate cost effectiveness is shown to be from \$570-\$5,700/ton SO<sub>2</sub> removed. This information demonstrates a strong cost effectiveness advantage realized by installing control devices on the larger emission units. (Converted from 2001 to 2006 dollars using a conversion factor of 1.1383 [www.inflationdata.com](http://www.inflationdata.com))

In another independent analysis of control costs, Integrated Planning Model (IPM<sup>®</sup>) background documentation defines a range of control efficiencies, costs, and applicability based on unit size and coal type. (<http://www.epa.gov/airmarkets/progsregs/epa-ipm/past-modeling.html>) Two wet scrubber (wet FGD) control technologies are discussed in Integrated Planning Model (IPM<sup>®</sup>)



background documentation; (1) Limestone Forced Oxidation (LSFO), and (2) Magnesium Enhanced Lime (MEL). Both of the scrubber control technologies are applicable to distinct unit sizes and coal types, but there is no indication in the parsed Integrated Planning Model (IPM<sup>®</sup>) results as to which type of scrubber has been applied by the model. Both scrubber technologies are assumed to achieve a SO<sub>2</sub> removal percentage of 95% or greater. According to Integrated Planning Model (IPM<sup>®</sup>) documentation, the costs used by Integrated Planning Model (IPM<sup>®</sup>) for these control technologies were developed by EPA and presented in a document titled *Emissions: A Review of Technologies*, (EPA-600/R-00-093), October 2000 prepared by EPA's Office of Research and Development. The cost and performance calculations were primarily a function of heat rate, capacity, and sulfur content. The range of various scrubber costs is included in Attachment 1. Using the data in Attachment 1 and applying a standard engineering economics analysis (Attachment 2), the costs of SO<sub>2</sub> removal using these control technologies vary from approximately \$300-\$1,100 per ton of SO<sub>2</sub> removal, (Converted from 1999 to 2006 dollars using a conversion factor of 1.2101 [www.inflationdata.com](http://www.inflationdata.com)).

#### Cost of Flue Gas Desulfurization (FGD) – Spray Dry

The cost of flue gas desulfurization varies depending on a number of factors including the size of the boiler, SO<sub>2</sub> reduction requirements, boiler capacity factor, and fuel sulfur content. Taking these factors into account, the typical cost effectiveness of a 1,000 MMBTU/hr (~300MW) coal-fired boiler equipped with spray dry FGD is around \$420 per ton of SO<sub>2</sub> reduced. This cost is based on a boiler capacity factor of 83% and SO<sub>2</sub> removal efficiency of 90%. (*Controlling Fine Particulate Matter Under the Clean Air Act: A Menu of Options*, STAPPA-ALAPCO, March 2006) (Converted from 2003 to 2006 dollars using a conversion factor of 1.0959 [www.inflationdata.com](http://www.inflationdata.com))

EPA reports in a 2005 document titled *Multipollutant Emission Control Technology Options for Coal-fired Power Plants*, that conventional Spray Dry FGD systems can cost from \$155-\$237 per kW, have fixed operation and maintenance costs ranging from \$1.55-\$7.25 per kW-yr, and variable operation and maintenance costs from 0.2-0.7 mills/kWh. These costs are associated with a 300 MW plant. (Converted from 2005 to 2006 dollars using a conversion factor of 1.0322 [www.inflationdata.com](http://www.inflationdata.com))

A similar cost estimation from STAPPA-ALAPCO, 2006 provides information for boilers in the size range of >2,000 MMBTU/hr (~600 MW) and <2,000 MMBTU/hr achieving from 80-90% SO<sub>2</sub> removal efficiency. These cost estimates provide the initial and ongoing costs of installing wet scrubbers. For units >600 MW, the capital costs are between \$140-\$510/MW; operation and maintenance costs range from \$14-\$34/MW; and the ultimate cost effectiveness is shown to be from \$170-\$340/ton SO<sub>2</sub> removed. For boilers <600 MW per hour, the capital costs are between \$510-\$5,100/MW; operation and maintenance costs (O&M) range from \$34-\$1,020/MW; and the ultimate cost effectiveness is shown to be from \$570-\$4,550/ton removed. As was the case with wet scrubbers, this information demonstrates a strong cost effectiveness advantage realized by installing control devices on the larger emission units. (Converted from 2001 to 2006 dollars using a conversion factor of 1.1383 [www.inflationdata.com](http://www.inflationdata.com))

Integrated Planning Model (IPM<sup>®</sup>) background documentation defines a range of control efficiencies, costs, and applicability based on unit size and coal type.

(<http://www.epa.gov/airmarkets/progsregs/epa-ipm/past-modeling.html>) Lime Spray Dry (LSD) technology is one form of SO<sub>2</sub> control applied by Integrated Planning Model (IPM<sup>®</sup>). LSD is assumed to achieve a SO<sub>2</sub> removal percentage of 90%. According to Integrated Planning Model (IPM<sup>®</sup>) documentation, the costs used by Integrated Planning Model (IPM<sup>®</sup>) for these control technologies were developed by EPA and presented in a document titled *Emissions: A Review of Technologies*, (EPA-600/R-00-093), October 2000 prepared by EPA's Office of Research and Development. The cost and performance calculations were primarily a function of heat rate, capacity, and sulfur content. The range of various scrubber costs is included in Attachment 1. Depending on boiler size, boiler capacity factor, and coal sulfur content, the fixed capital costs range from \$142 to \$183/kW, while fixed operation and maintenance costs (O&M) range from \$5 to \$7/kW-yr and variable O&M costs range from 1.9 to 2.4 mills/kWh. Assuming the typical costs in Attachment 1, an EGU rated 800 MW, a capital cost investment of \$156/kW or \$125 million would be expected. Fixed O&M and variable O&M costs would be approximately \$6/kW-yr and 2.2 mills/kWh respectively and would depend on the EGU annual output. This cost could be expected to reduce SO<sub>2</sub> emissions by 90%. The cost and performance calculations were primarily a function of heat rate, capacity, and sulfur content. Using the data in Attachment 1 and applying a standard engineering economics analysis (Attachment 2), the costs of SO<sub>2</sub> removal using this control technology varies from approximately \$480-\$600 per ton of SO<sub>2</sub> removal, (Converted from 1999 to 2006 dollars using a conversion factor of 1.2101 [www.inflationdata.com](http://www.inflationdata.com)).

#### Cost of Flue Gas Desulfurization (FGD) – Dry

The cost of flue gas desulfurization varies depending on a number of factors including the size of the boiler, SO<sub>2</sub> reduction requirements, boiler capacity factor, and fuel sulfur content. Taking these factors into account, the typical cost effectiveness of a 1,000 MMBTU/hr (~300MW) coal-fired boiler equipped with dry FGD is around \$693 per ton of SO<sub>2</sub> reduced when combusting high-sulfur coal. This cost is based on a boiler capacity factor of 83% and SO<sub>2</sub> removal efficiency of 40%. Assuming the same boiler and SO<sub>2</sub> control efficiency, but firing low-sulfur coal, the cost per ton is slightly higher at \$764 per ton of SO<sub>2</sub> controlled. (*Controlling Fine Particulate Matter Under the Clean Air Act: A Menu of Options*, STAPPA-ALAPCO, March 2006) (Converted from 2003 to 2006 dollars using a conversion factor of 1.0959 [www.inflationdata.com](http://www.inflationdata.com))

The 2005 EPA document titled, *Multipollutant Emission Control Technology Options for Coal-fired Power Plants*, shows that advanced dry FGD systems can cost from \$50-\$150 per kW, have fixed operation and maintenance costs ranging from <\$1 -\$3 per kW-yr, (based on 1-2% of capital), and variable operation and maintenance costs from 0.2-0.7 mills/kWh. Assuming an SO<sub>2</sub> reduction percentage of 40%, capacity factor of 85%, coal sulfur content of 1.5%, and coal heat content of 12,000 BTU/lb and applying a standard engineering economics analysis (Attachment 2), the costs of SO<sub>2</sub> removal using this control technology varies from approximately \$250-\$850 per ton (Converted from 2005 to 2006 dollars using a conversion factor of 1.0322 [www.inflationdata.com](http://www.inflationdata.com)).

Summary of SO<sub>2</sub> Reduction Costs

The cost of SO<sub>2</sub> reductions on a per ton basis for EGUs is dependent on the cost (and availability) of fuels, boiler size and type, equipment retrofit costs, the desired emission reduction, and other site specific factors. Although these factors can cause the cost of the reductions to be well above or below the industry average, a summary of estimated ranges for SO<sub>2</sub> reductions is included in Table 2.6 for FGDs. Sufficient data were not available to calculate a range of costs with reasonable certainty for fuel switching or coal cleaning. Within the range of estimated costs for a given boiler size, the low end of the SO<sub>2</sub> reduction cost is generally associated with a high boiler capacity factor. The reason for this is due to the high capital costs and fixed operation and maintenance costs of the control device. With higher boiler capacity factors, the control device is able to reduce more tons of SO<sub>2</sub>, which effectively reduces the per ton cost of the reduction.

**Table 2.6 Estimated Cost Ranges for SO<sub>2</sub> Control Options for Coal-fired EGU Boilers (2006 dollars/ton of SO<sub>2</sub> Reduced)**

Technology	Description	Performance	Cost Range (2006 dollars/ton of SO <sub>2</sub> Reduced)
Switch to a Low Sulfur Coal (generally <1% sulfur)	Replace high-sulfur bituminous coal combustion with lower-sulfur coal	50-80% reduction in SO <sub>2</sub> emissions by switching to a lower-sulfur coal	Potential reduction in coal costs, but possibly offset by expensive retrofits and loss of boiler efficiency
Switch to natural gas (virtually 0% sulfur)	Replace coal combustion with natural gas	Virtually eliminate SO <sub>2</sub> emissions by switching to natural gas	Unknown – cost of switch is currently uneconomical due to price of natural gas
Coal Cleaning	Coal is washed to remove some of the sulfur and ash prior to combustion	20-25% reduction in SO <sub>2</sub> emissions	2-15% increase in fuel costs based on current prices of coal
Flue Gas Desulfurization (FGD) – Wet	SO <sub>2</sub> is removed from flue gas by dissolving it in a lime or limestone slurry. (Other alkaline chemicals are sometimes used)	30-95%+ reduction in SO <sub>2</sub> emissions	\$570-\$5,700 for EGUs <1,200 MW \$330-\$570 for EGUs >1,200 MW
Flue Gas Desulfurization (FGD) – Spray Dry	A fine mist containing lime or other suitable sorbent is injected directly into flue gas	60-95%+ reduction in SO <sub>2</sub> emissions	\$570-\$4,550 for EGUs <600 MW \$170-\$340 for EGUs >600 MW
Flue Gas Desulfurization (FGD) –Dry	Powdered lime or other suitable sorbent is injected directly into flue gas	40-60% reduction in SO <sub>2</sub> emissions	\$250-\$850 for EGUs ~300 MW

Table references:

1. EIA website accessed on 2/20/07: <http://www.eia.doe.gov/cneaf/coal/page/coalnews/coalmar.html>
2. EIA website accessed on 2/20/07: <http://www.eia.doe.gov/cneaf/coal/page/acr/table31.html>
3. STAPPA-ALAPCO. *Controlling Fine Particulate Matter Under the Clean Air Act: A Menu of Options*; March 2006.

4. U.S. EPA. EPA-600/R-05/034; *Multipollutant Emission Control Technology Options for Coal-fired Power Plants*; March 2005.
5. U.S. EPA. Integrated Planning Model (IPM<sup>®</sup>) background documentation located on website:  
<http://www.epa.gov/airmarkets/progsregs/epa-ipm/past-modeling.html>
6. *Final Draft Report - Comparison of CAIR and CAIR Plus Proposal Using the Integrated Planning Model (IPM<sup>®</sup>)*, ICF Resources; May 30, 2007.
7. World Bank Organization. Information located on website:  
<http://www.worldbank.org/html/fpd/em/power/EA/mitigatn/aqsocc.stm>

### **Time Necessary for Compliance**

Generally, sources are given a 2-4 year phase-in period to comply with new rules. Under the previous Phase I of the NO<sub>x</sub> SIP Call, EPA provided a compliance date of about 3½ years from the SIP submittal date. Most MACT standards allow a 3-year compliance period. Under Phase I of the NO<sub>x</sub> SIP Call, EPA provided a 2-year period after the SIP submittal date for compliance. States generally provided a 2-year period for compliance with RACT rules. For the purposes of this review, we have assumed that a maximum of 2 years after SIP submittal is adequate for pre-combustion controls (fuel switching or cleaning) and a maximum of 3 years is adequate for the installation of post combustion controls.

For post-combustion controls, site-specific information must be supplied to vendors in order to determine the actual time needed for installation of a given control. Large scale implementation of control devices within the EGU sector, particularly in a short time period, may require consideration of impacts on regional electricity demands. Integrated Planning Model (IPM<sup>®</sup>) has allowed for these and other impacts in determining the least cost approach to emission reductions, however, there is a great deal of uncertainty associated with modeled results in comparison to real-world applications of control strategies.

For BART control measures, the proposed BART guidelines require States to establish enforceable limits and require compliance with the BART emission limitations no later than 5 years after EPA approves the regional haze SIP.

### **Energy and Non-Air Impacts**

Fuel switching and cleaning may add to transportation issues and secondary environmental impacts from waste disposal and material handling operations (e.g. fugitive dust). Additionally, these SO<sub>2</sub> control methods can create fuel supply problems if several large customers of various types of coal suddenly make changes in purchasing patterns. The main impact would be on the stability of fuel prices. It is not likely that this would be a persistent problem.

Another impact of fuel switching is that the modifications required for switching from one fuel to another may require a unit to be examined for major NSR permitting requirements. This is true even for modifications required for addition of controls since the modifications could trigger the definition of a "significant modification" under NSR/PSD.

Fuel switching between types and geographic sources of coal and installation of control devices can significantly effect mercury emissions. Data from EPA's Mercury Information Collection Request (ICR) revealed that many power plants have existing mercury capture as a co-benefit of air pollution control technologies for NO<sub>x</sub>, SO<sub>2</sub> and PM. This includes capture of particulate-bound mercury in PM control equipment and capture of soluble ionic mercury in wet FGD

systems. Additional data have also shown that the use of SCR for NO<sub>x</sub> control enhances oxidation of elemental mercury to the soluble ionic form, resulting in increased removal in the wet FGD system for units burning bituminous coal. Overall the ICR data revealed higher levels of Hg capture for bituminous coal-fired plants as compared to subbituminous coal-fired plants. Other factors that influence mercury emissions from coal combustion are chlorine content of the coal and fly ash composition.

FGD systems typically operate with high pressure drops across the control equipment, resulting in a significant amount of electricity required to operate blowers and circulation pumps. In addition, some combinations of FGD technology and plant configuration may require flue gas reheating to prevent physical damage to equipment, resulting in higher fuel usage. According to Integrated Planning Model (IPM<sup>®</sup>) background documentation, wet FGD systems reduce the capacity of the EGU by 2.1%. This means that the scrubber reduces the amount of electricity for sale to the grid by 2.1%. The main effect of this reduction is the increased cost of energy production.

The primary environmental impact of FGD systems is the generation of wastewater and sludge from the SO<sub>2</sub> removal process. When the exhaust gas from the boiler enters the FGD the SO<sub>2</sub>, metals, and other solids are removed from the exhaust and collected in the FGD liquid. The liquid slurry collects in the bottom of the FGD in a reaction tank. The slurry is then dewatered and a portion of the contaminant-laden water is removed from the system as wastewater. Waste from the FGD systems will increase sulfate, metals, and solids loading in a facility's wastewater, potentially impacting community wastewater treatment facilities for smaller units that do not have self contained water treatment systems. In some cases FGD operation necessitates installation of a clarifier on site to remove excessive pollutants from wastewater. This places additional burdens on a facility or community wastewater treatment and solid waste management capabilities. These impacts will need to be analyzed on a site-specific basis. If lime or limestone scrubbing is used to produce calcium sulfite sludge, the sludge must be stabilized prior to land filling. If a calcium sulfate sludge is produced, dewatering alone is necessary before land filling, however, SO<sub>2</sub> removal costs are higher due to increased equipment costs for this type of control system. In some cases calcium sulfate sludge can be sold for use in cement manufacturing.

With wet FGD technologies a significant visible plume is present from the source due to condensation of water vapor as it exits the smoke stack. Although the water eventually evaporates and the plume disappears, community impact may be significant.

### **Remaining Useful Life of the Source**

Available information for remaining useful life estimates of EGU boilers indicates a wide range of operating lifetimes, depending on size of the unit, capacity factor, and level of maintenance performed. Typical life expectancies range to 50 years or more. Additionally, implementation of regulations over the years has resulted in retrofitting that has ultimately increased the expected life span of many EGUs. The lifetime of an EGU may be extended through repair, repowering, or other strategies if the unit is more economical to run than to replace with power from other sources. This may be particularly likely if the unit serves an area which has limited transmission capacity available to bring in other power.

## REFERENCES

2002 MANE-VU Emissions Inventory Version 3.

EPA Clean Air Markets Division, (CAMD). Personal communication regarding control at coal-fired EGUs in the United States from Mr. Peter Kokopeli (202-343-9085), (kokopeli.peter@epa.gov) via E-mail on April 3 and April 10, 2007.

NESCAUM. *Assessment of Control Technology Options for BART-Eligible Sources*; March, 2005.

Midwest RPO. *Candidate Control Measures – Source Category: Electric Generating Units*; 12/09/2005.

STAPPA-ALAPCO. *Controlling Fine Particulate Matter Under the Clean Air Act: A Menu of Options*; March 2006.

Evans, David A; Hobbs, B.F.; Oren, C.; Palmer, K.L. *Modeling the Effects of Changes in New Source Review on National SO<sub>2</sub> and NO<sub>x</sub> Emissions from Electricity-Generating Units*.

U.S. EPA. EPA-600/R-05/034; *Multipollutant Emission Control Technology Options for Coal-fired Power Plants*; March 2005.

U.S. EPA. Integrated Planning Model (IPM<sup>®</sup>) background documentation located on website: (<http://www.epa.gov/airmarkets/progsregs/epa-ipm/past-modeling.html>)

ICF Resources. *Final Draft Report - Comparison of CAIR and CAIR Plus Proposal Using the Integrated Planning Model (IPM<sup>®</sup>)*, May 30, 2007.

GE Water & Process Technologies. Information accessed on web March 27, 2007:  
[http://www.zenon.com/applications/FGD\\_wastewater\\_treatment.shtml](http://www.zenon.com/applications/FGD_wastewater_treatment.shtml)

Energy Information Administration (EIA). Information located on website:  
<http://www.eia.doe.gov/cneaf/coal/page/coalnews/coalmar.html>

Energy Information Administration (EIA). Information located on website:  
<http://www.eia.doe.gov/cneaf/coal/page/acr/table31.html>

Energy Information Administration (EIA). Information located on website:  
[http://www.eia.doe.gov/cneaf/electricity/epm/epm\\_sum.html](http://www.eia.doe.gov/cneaf/electricity/epm/epm_sum.html)

World Bank Organization. Information located on website:  
<http://www.worldbank.org/html/fpd/em/power/EA/mitigatn/aqsocc.stm>

## CHAPTER 3

### ANALYSIS OF SELECTED ELECTRIC GENERATING UNITS (EGUs)

#### EGU FACILITY CONTROLS

The Vermont Department of Environmental Conservation (VTDEC) used the CALPUFF model to estimate sulfate ion impacts from large EGUs and determine the major EGUs and process units (boilers) at the EGUs that contribute to visibility impairment in Class I MANE-VU areas and Class I areas affected by emissions from sources within MANE-VU (See Chapter 1, for more details). Modeling was based on 2002 SO<sub>2</sub> emissions, and the results of the modeling showed the SO<sub>2</sub> emissions of the 100 highest emitting EGUs and the contribution of these sources toward the SO<sub>2</sub> concentration in each of the Class I areas. Proximity of the individual sources to Class I areas and variations in meteorology on the 20% worst visibility days resulted in varying impacts from individual sources on each Class I area. In subsequent discussions with MARAMA and the Reasonable Progress Workgroup, MACTEC was directed to focus on the emissions from the top 30 individual sources for this analysis. The 30 individual sources are located at 23 distinct facilities. The location of the 23 EGU facilities of interest is included in Figure 3.1.

Since EGUs are the largest emitters of SO<sub>2</sub> in the United States and have the greatest impact on haze in the MANE-VU Class I areas, it is particularly useful to determine what controls have recently been applied at these facilities (since the 2002 emission inventory). Also important is information about controls that are currently being applied at facilities, or are planned for addition in the future.

MACTEC gathered information from two primary sources of data for analysis of controls to be applied at the 30 EGUs.

1. Integrated Planning Model (IPM<sup>®</sup>) results from the MANE-VU CAIR Plus (MARAMA 4c) run.
2. Information from State agencies with facilities in the list of the top 30 individual sources. We requested EGU permit information, information about SO<sub>2</sub> controls recently implemented or planned at the facility and any available information on BART, consent decrees, or other regulations that will impact EGU control devices.

The MANE-VU CAIR Plus model results represent an estimate of the additional controls that might be installed under a more stringent cap and trade program in the Eastern U.S. The comparison of this estimate to the known planned controls for these 30 key EGUs is intended to give an idea of whether a stricter cap would in fact result in great controls at these sources.

**Figure 3.1**

**EGU Facilities with the Greatest Visibility Impacts  
in Mid-Atlantic North Eastern Class I Areas**



Note: Some facilities are too close to differentiate on the map

### **INTEGRATED PLANNING MODEL (IPM<sup>®</sup>) ANALYSIS**

For EGUs, EPA used the Integrated Planning Model (IPM<sup>®</sup>) to estimate which units will install controls at what costs and which units will buy credits. The RPOs also made some Integrated Planning Model (IPM<sup>®</sup>) runs to determine which units will install controls to comply with the EPA CAIR rule. Additionally, an even more stringent “CAIR Plus” strategy was investigated using the Integrated Planning Model (IPM<sup>®</sup>). The parsed results which include modeled control scenarios for individual EGUs were used to help determine costs for EGUs, and ultimately estimate the marginal cost of SO<sub>2</sub> reductions for the model planning years of 2009, 2012, and 2018.

MACTEC obtained information from the CAIR Plus Policy Case, (MARAMA\_4c) for the years 2009, 2012, and 2018 for the 30 EGUs. The information obtained included unit design capacity, SO<sub>2</sub> emissions, assumed existing controls, and controls to be applied as calculated by the Integrated Planning Model (IPM<sup>®</sup>). The information was available for each of the individual years, (2009, 2012, and 2018). Also available were the resulting changes in design capacity due to controls, production output, or other factors from Integrated Planning Model (IPM<sup>®</sup>). The parsed model data do not supply specific design information pertaining to the scrubber size,



costs, or other related information for individual units. It is only possible to determine the year that the scrubber is due to be installed on individual process units. Information from the CAIR Plus Integrated Planning Model (IPM<sup>®</sup>) run is included in Table 3.1. Integrated Planning Model (IPM<sup>®</sup>) projections in Table 3.1 are not intended to be interpreted literally, but only as an example of the least-cost results from one set of inputs to the model. Also, the controls applied by Integrated Planning Model (IPM<sup>®</sup>) may differ from planned controls at the facility. For information on planned controls at these facilities, please see Table 3.2

**Table 3.1 Integrated Planning Model (IPM® version 2.1.9) CAIR Plus Projections for the Top 30 EGUs Responsible for Visibility Impairment in MANE-VU Class I Areas**

State	Facility ID	Facility	Primary Emissions Point Descriptions	Point #	2002 SO <sub>2</sub> Total (Tons) <sup>1</sup>	2018 SO <sub>2</sub> Total (Tons) <sup>2</sup>	SO <sub>2</sub> Reduction (2002-2018) (Tons/Year) <sup>3</sup>	% SO <sub>2</sub> Reduction (2002-2018) <sup>3</sup>	Design Capacity <sup>4</sup>	Existing Control <sup>4</sup>	MANE_VU CAIR Plus Projection <sup>5</sup>
TN	D03406C10	Johnsonville	Coal - wall fired; dry bottom boiler	10	108,789	46,000	63,000	58%	15,688 MMBTU	Cold-side ESP, LNB	SCR by 2012
OH	D028404	Conesville	Coal - tangential, dry bottom boiler	4	92,340	7,000	85,000	92%	764 MW	Cold-side ESP; LNB + OFA + BOOS	SCR and Scrubber by 2009
PA	D031361	Keystone	Coal - tangential; dry bottom boiler	1	87,709	5,000	83,000	94%	8,010 MMBTU	Cold-side ESP + SCR; LNB; OFA	Scrubber by 2009
OH	D02872C04	Muskingum River	Coal - cyclone, wet bottom boiler	4	24,484	1,000	23,000	96%	205 MW to 201 MW by 2012	Cold-side ESP; OFA	SCR and Scrubber by 2012
PA	D03179C01	Hatfield's Ferry	Coal - wall fired; dry bottom boiler	1	55,695	13,000	43,000	77%	5,766 MMBTU	Cold-side ESP + SNCR; LNB	None
OH	D02876C01	Kyger Creek	Coal - wall fired, wet bottom boiler	1	13,789	1,000	13,000	93%	13,789 MMBTU	Cold-side ESP + SCR; OFA	Scrubber by 2012
WV	D03935C02	John E. Amos	Coal - wall fired, dry bottom boiler	2	31,465	6,000	25,000	81%	7,020 MMBTU	Cold-side ESP + SCR; LNB	Scrubber
PA	D031362	Keystone	Coal - tangential; dry	2	62,890	4,000	59,000	94%	8,010 MMBTU	Cold-side ESP + SCR; LNB; OFA	Scrubber by 2009
IN	D01010C05	Wabash River	Coal - wall fired, dry bottom boiler	5	9,380	1,000	8,000	89%	95 MW	Cold-side ESP + Cyclone; LNB + OFA	SNCR by 2009
PA	D031491	Montour	Coal - tangential; dry bottom boiler	1	61,005	4,000	57,000	93%	744 MW	Cold-side ESP + SCR; LNB + OFA	Scrubber by 2009
NC	D080421	Belews Creek	Coal - wall fired; dry bottom boiler	1	57,848	3,000	55,000	95%	1,096 MW	Cold-side ESP + SCR; LNB	Mercury control
WV	D03948C02	Mitchell	Coal - wall fired; dry bottom boiler	2	29,532	6,000	24,000	80%	7,020 MMBTU	Cold-side ESP + SCR + Wet Scrubber; LNB	None
PA	D031222	Homer City	Coal - wall fired; dry bottom boiler	2	55,346	3,000	52,000	95%	6,792 MMBTU	Cold-side ESP + SCR; LNB + OFA	Scrubber by 2009
PA	D031492	Montour	Coal - tangential; dry bottom boiler	2	50,441	4,000	46,000	92%	729 MW	Cold-side ESP + SCR; LNB + OFA	Scrubber by 2009
MD	D01571CE2	Chalk Point	Coal - wall fired; dry bottom boiler	2	23,537	2,000	22,000	92%	335 MW	Cold-side ESP; LNB	SCR and Scrubber by 2009
MI	D01733C12	Monroe	Coal - cell fired, dry bottom boilers	1 & 2	48,563	28,000	21,000	42%	770, 785 MW	Cold-side ESP + SCR, LNB	None
PA	D031221	Homer City	Coal - wall fired, dry bottom boiler	1	45,745	3,000	43,000	93%	607 MW	Cold-side ESP + SCR; LNB + OFA	Scrubber by 2009
NC	D080422	Belews Creek	Coal - wall fired, dry bottom boiler	2	45,236	3,000	42,000	93%	1,096 MW	Cold-side ESP + SCR; LNB	Mercury control
WV	D039432	Fort Martin	Coal - wall fired, dry bottom boiler	2	45,890	5,000	41,000	89%	4,634 MMBTU	Cold-side ESP + SNCR; LNB + OFA	Scrubber by 2012
WV	D039431	Fort Martin	Coal - tangential; dry bottom boiler	1	45,228	5,000	40,000	89%	4,460 MMBTU	Cold-side ESP + SNCR; LNB + OFA	Scrubber by 2012
WV	D039353	John E Amos	Coal - wall fired; dry bottom boiler	3	44,030	9,000	35,000	80%	11,900 MMBTU	Cold-side ESP + SCR; LNB	Scrubber

**Table 3.1 Integrated Planning Model (IPM<sup>®</sup> version 2.1.9) CAIR Plus Projections for the Top 30 EGUs Responsible for Visibility Impairment in MANE-VU Class I Areas**

State	Facility ID	Facility	Primary Emissions Point Descriptions	Point #	2002 SO <sub>2</sub> Total (Tons) <sup>1</sup>	2018 SO <sub>2</sub> Total (Tons) <sup>2</sup>	SO <sub>2</sub> Reduction (2002-2018) (Tons/Year) <sup>3</sup>	% SO <sub>2</sub> Reduction (2002-2018) <sup>3</sup>	Design Capacity <sup>4</sup>	Existing Control <sup>4</sup>	MANE_VU CAIR Plus Projection <sup>5</sup>
OH	D0283612	Avon Lake	Coal - wall fired; dry bottom boiler	12	41,872	6,000	36,000	86%	6,040 MMBTU	Cold-side ESP	Scrubber by 2009, SCR by 2012
VA	D037976	Chesterfield	Coal - tangential; dry bottom boiler	6	40,923	4,000	37,000	90%	6,650 MMBTU	Cold-side ESP; LNB + OFA	SCR and Scrubber by 2012
PA	D082261	Cheswick	Coal - tangential; dry bottom boiler	1	42,018	5,000	37,000	88%	550 MW	Cold-side ESP + SCR; LNB + OFA	Scrubber by 2009
OH	D028281	Cardinal	Coal - cell fired; dry bottom boilers	1	39,894	2,000	38,000	95%	600 MW to 587 MW in 2012	Cold-side ESP + SCR; LNB	Scrubber by 2012
MD	D015731	Morgantown	Coal - tangential; dry bottom boiler	1	37,757	3,000	35,000	92%	570 MW	Cold-side ESP; LNB + OFA	SCR and Scrubber by 2009
OH	D028667	W H Sammis	Coal - wall fired; dry bottom boiler	7	33,720	3,000	31,000	91%	593 MW to 818 MW in 2012	Cold-side ESP + SNCR, LNB	Scrubber in 2009; Coal to IGCC in 2012
MD	D015732	Morgantown	Coal - tangential; dry bottom boiler	2	32,587	3,000	30,000	91%	570 MW	Cold-side ESP; LNB + OFA	SCR and Scrubber by 2009
MA	D016193	Brayton Point	Coal - wall fired; dry bottom boiler	3	19,451	3,000	16,000	85%	5,800 MMBTU	Cold-side ESP; LNB + OFA	SCR, Scrubber, Mercury Control by 2009
NJ	D023781	B L England	Coal - cyclone; wet bottom boiler	1	10,080	1,000	9,000	90%	129 MW	Cold-side ESP; + SNCR; OFA	None

Note: CEMS hourly data was used in the modeling of the emission units, not annual emissions. Also, a single emission unit at a generating plant may represent two or more emission units at that plant emitting from the same stack point. (Refer to the detailed explanation in the Introduction section of this report).

Table references:

1. 2002 SO<sub>2</sub> total for the emission point from RPO emission inventory
2. Integrated Planning Model (IPM<sup>®</sup>) CAIR Plus projected 2018 SO<sub>2</sub> total for the emission point (rounded to nearest 1,000 tons)
3. Approximate reduction in SO<sub>2</sub> emissions for 2018 Integrated Planning Model (IPM<sup>®</sup>) versus 2002 RPO emission inventory (rounded to nearest 1,000 tons)
4. Information from Integrated Planning Model (IPM<sup>®</sup>) and RPO emission inventories
5. Information from Integrated Planning Model (IPM<sup>®</sup>) CAIR Plus Scenario

Integrated Planning Model (IPM<sup>®</sup>) background documentation defines a range of control efficiencies, costs, and applicability based on unit size and coal type. (<http://www.epa.gov/airmarkets/progsregs/epa-ipm/past-modeling.html>) Three scrubber control technologies are discussed briefly in Integrated Planning Model (IPM<sup>®</sup>) background documentation; 1. Limestone Forced Oxidation (LSFO), 2. Magnesium Enhanced Lime (MEL) and 3. Lime Spray Dryer (LSD). Each of the three scrubber control technologies are applicable for distinct unit sizes and coal types, but there is no indication in the parsed Integrated Planning Model (IPM<sup>®</sup>) results as to which type of scrubber has been applied by the model. All three scrubber technologies are assumed to achieve a SO<sub>2</sub> removal percentage of 90% or greater. The range of various scrubber costs is included in Attachment 1. Depending on boiler size, boiler capacity factor, and coal sulfur content, the fixed capital costs range from \$140 to \$580/kW, while fixed operation and maintenance costs (O&M) range from \$5 to \$24/kW-yr and variable O&M costs range from 1.0 to 2.4 mills/kWh. Assuming the typical costs in Attachment 1, an EGU rated 500 MW, (the approximate average of the 30 units included in this analysis), a capital cost investment of \$216/kW or \$110 million would be expected. Fixed O&M and variable O&M costs would be approximately \$11/kW-yr and 2.0 mills/kWh, respectively and would depend on the EGU annual output. This cost could be expected to reduce SO<sub>2</sub> emissions by greater than 90%. A typical SO<sub>2</sub> reduction from a 500 MW unit (assuming a minimum of 90% reduction), based on the 30 units included in this analysis would be from 4,000 to 40,000 tons annually. (Converted from 1999 to 2006 dollars using a conversion factor of 1.2101 [www.inflationdata.com](http://www.inflationdata.com))

## **INFORMATION OBTAINED FROM STATE AGENCIES**

The 30 EGUs analyzed here are already subject to a variety of existing emission control requirements, including CAIR, BART, mercury controls, the NO<sub>x</sub> SIP call, and EPA's acid rain control program. Therefore, it is expected that at least some of the 30 EGUs will already be adding control by 2018.

To investigate this possibility, MACTEC contacted State agencies with facilities in the list of the top 30 individual sources. We requested EGU permit information, information about SO<sub>2</sub> controls recently implemented or planned at the facility, and any available information on BART, consent decrees, or other regulations that will impact EGU control devices. The information we have obtained is included in Table 3.2.

**Table 3.2 Point Source Information for the Top 30 EGUs Responsible for  
 Visibility Impairment in MANE-VU Class I Areas**

Facility Name	State	2002 SO <sub>2</sub> Total (tons) <sup>a</sup>	Primary Emissions Point Description	Point ID (Permit ID No.)	Design Capacity	Existing Control(s)	Proposed/Planned Control(s)	Additional Information
Johnsonville <sup>1, 2, 3</sup>	TN	108,789	Coal-fired Boilers 01-10 for steam & electricity generation. The units are pulverized coal, dry-bottom boilers without fly ash reinjection. Units 1-6 are Combustion Engineering tangentially-fired boilers. Units 7-10 are Foster Wheeler wall fired boilers. All boilers exhaust through a common stack.	43-0011-01-10	15,688 MMBTU/hr	ESP	Combustion of low-sulfur fuel (since 2002) SCR by 2018	2018 SO <sub>2</sub> emissions will be approximately 51,000 tpy
Conesville <sup>4</sup>	OH	92,340	Unit 4 Main Boiler - Combustion Engineering model 7868 pulverized coal-fired, dry-bottom boiler	B004	7,960 MMBTU/hr	ESP	FGD and SCR by 8/18/09	N/A
Keystone (aka Reliant Energy Northeast Mgmt/Keystone Power Plant) <sup>5</sup>	PA	87,709	Boiler 1 w/low NO <sub>x</sub> burner	1 (031)	8,717 MMBTU/hr	Cold-side ESP SCR	FGD	Alternate operation: SCR System Boiler 1
Muskingum River <sup>6</sup>	OH	24,484	Unit 3 Main Boiler - Babcock and Wilcox model RB-248 (custom) coal-fired, cyclone boiler	B004	2,150 MMBTU/hr	ESP	None planned	N/A

**Table 3.2 Point Source Information for the Top 30 EGUs Responsible for Visibility Impairment in MANE-VU Class I Areas**

Facility Name	State	2002 SO <sub>2</sub> Total (tons) <sup>a</sup>	Primary Emissions Point Description	Point ID (Permit ID No.)	Design Capacity	Existing Control(s)	Proposed/Planned Control(s)	Additional Information
Hatfield's Ferry <sup>5</sup>	PA	55,695	Babcock & Wilcox Boiler #1 that burns bituminous coal (227 tons/hr) and No. 2 fuel oil (1,384 gal/hr)	1 (031)	5,766 MMBTU/hr	Cold-side ESP	FGD	N/A
Kyger Creek <sup>6</sup>	OH	13,789	Unit #1 Boiler- Babcock and Wilcox pulverized coal-fired, wet-bottom boiler	B001	1,850 MMBTU/hr	ESP	SCR, FGD operational by 1/01/09	N/A
John E. Amos <sup>7,8</sup>	WV	31,465	Dry-bottom wall-fired coal boiler	2	800 MW, 7,020 MMBTU/hr	ESP Low NO <sub>x</sub> burners SCR	FGD (12/2008)	Vents through CS012
Keystone (aka Reliant Energy Northeast Mgmt/Keystone Power Plant) <sup>5</sup>	PA	62,890	Boiler 2 w/low NO <sub>x</sub> burner	2 (032)	8,717 MMBTU/hr	Cold-side ESP SCR	FGD	Alternate operation: SCR System Boiler 2
Wabash (aka Duke Energy Indiana, Inc. - Wabash River Generating Station) <sup>9, 10</sup>	IN	9,380	Wall fired coal electric utility boiler (pulverized – dry bottom) constructed in 1956 using No. 2 fuel oil as ignition fuel	5	1,096.2 MMBTU/hr	Low- NO <sub>x</sub> burner (NO <sub>x</sub> ) ESP (PM)	None	Stack is equipped with CEM for SO <sub>2</sub>

**Table 3.2 Point Source Information for the Top 30 EGUs Responsible for Visibility Impairment in MANE-VU Class I Areas**

Facility Name	State	2002 SO <sub>2</sub> Total (tons) <sup>a</sup>	Primary Emissions Point Description	Point ID (Permit ID No.)	Design Capacity	Existing Control(s)	Proposed/Planned Control(s)	Additional Information
Montour (aka PPL Montour, LLC – Montour Steam Electric Station) <sup>5</sup>	PA	61,005	CE Boiler – Unit #1 that burns bituminous coal and No. 2 fuel oil	1 (031)	7,317 MMBTU/hr	Cold-side ESP SCR	FGD	N/A
Belews Creek (aka Duke Power's Belews Creek Plant) <sup>11</sup>	NC	57,848	Coal-fired electric utility boiler constructed in 1974	1	1,120 MW	None	Scrubbers (2008)	Expected rate under their compliance plan for the Clean Smokestacks Act is 0.150 lbs SO <sub>2</sub> /MMBTU. Expected emissions SO <sub>2</sub> for 2013 and later is 5,512 tpy.
Mitchell <sup>7, 12</sup>	WV	29,532	Dry-bottom wall-fired coal boiler	2	800 MW, 7,020 MMBTU/hr	ESP Low NO <sub>x</sub> burners	FGD (1/2007); SCR (4/2007)	Vents through CS012
Homer City (aka Homer City OL/Homer City Generation Station) <sup>13</sup>	PA	55,346	Boiler No. 2 (Unit 2)	2 (032)	6,792 MMBTU/hr	Cold-side ESP SCR	FGD	N/A
Montour (aka PPL Montour, LLC – Montour Steam Electric Station) <sup>5</sup>	PA	50,441	CE Boiler – Unit #2 that burns bituminous coal and No. 2 fuel oil	2 (032)	1,239 MMBTU/hr	Cold-side ESP SCR	FGD	N/A

**Table 3.2 Point Source Information for the Top 30 EGUs Responsible for Visibility Impairment in MANE-VU Class I Areas**

Facility Name	State	2002 SO <sub>2</sub> Total (tons) <sup>a</sup>	Primary Emissions Point Description	Point ID (Permit ID No.)	Design Capacity	Existing Control(s)	Proposed/Planned Control(s)	Additional Information
Chalk Point <sup>15, 16</sup>	MD	23,537	Steam Unit 2 is a wall fired, dry bottom, supercritical boiler base loaded unit. The primary fuel is coal with natural gas and No. 2 oil used for ignition.	2	342 MW	Low NO <sub>x</sub> burners ESP SACR LNBS & SOFA (NO <sub>x</sub> )	SCR and FGD (2009/2010 timeframe)	Unit covered under the MD Healthy Air Act
Monroe (aka Detroit Edison – Monroe Power Plant) <sup>16</sup>	MI	48,563	4 cell burner boilers (Boiler Unit Nos. 1, 2, 3, and 4) constructed in the late 1960s (1968-1969) and modified in 1994	EG01 EG02 EG03 EG04	3,000 MW (total)	Dry wire ESP (SO <sub>2</sub> ) FGD (Units 3 & 4) @ 97% CE	May put scrubbers on Units 1 & 2 later	If additional scrubbers are added, a SO <sub>2</sub> reduction of 97% is anticipated
Homer City (aka Homer City OL/Homer City Generation Station) <sup>13</sup>	PA	45,745	Boiler No. 1 (Unit 1)	1 (031)	6,792 MMBTU/hr	Cold-side ESP SCR	FGD	N/A
Belews Creek (aka Duke Power's Belews Creek Plant) <sup>11</sup>	NC	45,236	Coal-fired electric utility boiler constructed in 1975	2	1,120 MW	None	Scrubbers (2008)	Expected rate under their compliance plan for the Clean Smokestacks Act is 0.150 lbs SO <sub>2</sub> /MMBTU. Expected emissions SO <sub>2</sub> for 2013 and later is 4,639 tpy.



**Table 3.2 Point Source Information for the Top 30 EGUs Responsible for Visibility Impairment in MANE-VU Class I Areas**

Facility Name	State	2002 SO <sub>2</sub> Total (tons) <sup>a</sup>	Primary Emissions Point Description	Point ID (Permit ID No.)	Design Capacity	Existing Control(s)	Proposed/Planned Control(s)	Additional Information
Fort Martin <sup>7,8</sup>	WV	45,228	Tangentially-fired coal boiler	1	552 MW, 4,460 MMBTU/hr	ESP Low NO <sub>x</sub> burners SNCR Trim	FGD (4Q 2009)	N/A
Fort Martin <sup>7,8</sup>	WV	45,890	Wall-fired coal boiler	2	55 MW, 4,634 MMBTU/hr	ESP Low NO <sub>x</sub> burners SNCR Trim	FGD (1Q 2010)	N/A
John E. Amos <sup>7,8</sup>	WV	44,030	Dry-bottom wall-fired coal boiler	3	1,300 MW, 11,900 MMBTU/hr	ESP Low NO <sub>x</sub> burners SCR	FGD (12/2007)	N/A
Avon Lake <sup>6</sup>	OH	41,872	Boiler #12 - Pulverized coal-fired, dry bottom, boiler	B012	6,040 MMBTU/hr	ESP	SCR and FGD operational by 2010	N/A
Chesterfield (aka Chesterfield Power Station) <sup>17</sup>	VA	40,923	Combustion Engineering tangentially-fired coal boiler equipped with startup burners	6 (ES-6A)	6,650 MMBTU/hr	SCR ESP Stage combustion coal burners	FGD (95% CE under construction, operational 2008)	The unit is restricted to burn 2,330,160 tons/yr of coal at an annual average heating value of 12,500 BTU/lbs
Cheswick (aka Cheswick Power Station) <sup>18</sup>	PA	42,018	Tangentially-fired "main" boiler that burns bituminous coal (primary fuel), natural gas, and synfuel	1	5,500 MMBTU/hr (coal & synfuel) 1,000 MMBTU/hr (NG)	Low NO <sub>x</sub> burners SCR ESP w/flue gas conditioning (PM)	FGD (98% CE planned)	N/A

**Table 3.2 Point Source Information for the Top 30 EGUs Responsible for Visibility Impairment in MANE-VU Class I Areas**

Facility Name	State	2002 SO <sub>2</sub> Total (tons) <sup>a</sup>	Primary Emissions Point Description	Point ID (Permit ID No.)	Design Capacity	Existing Control(s)	Proposed/Planned Control(s)	Additional Information
Cardinal <sup>6, 12</sup>	OH	39,894	Unit 1 Main Boiler - Babcock and Wilcox, pulverized coal-fired, dry bottom, cell burner boiler	B001	527 MMBTU/hr	ESP	FGD (2/2008)	N/A
Morgantown <sup>14, 15</sup>	MD	37,757	Combustion Engineering, Inc., Unit Boiler No. 1 - steam generating coal-fired utility boiler installed in 1967 which primarily combusts Eastern Bituminous coal containing no more than 2% sulfur by weight and secondary fuel is No. 6 oil containing no more than 2% sulfur by weight	1 (F-1)	5,317 MMBTU/hr	ESP SO <sub>3</sub> injection Low NO <sub>x</sub> burners	SCR and FGD (2009/2010 timeframe)	Stacks equipped with SO <sub>2</sub> , NO <sub>x</sub> , CO <sub>2</sub> , and ultrasonic flow monitors. Unit covered under the MD Healthy Air Act.
W H Sammis <sup>6</sup>	OH	33,720	Coal Fired Boiler No.1 - Foster-Wheeler pulverized coal-fired, dry-bottom boiler	B007	1,822 MMBTU/hr	Fabric filter	ESP FGD operational 12/31/09 SNCR Operational 06/06	N/A

**Table 3.2 Point Source Information for the Top 30 EGUs Responsible for Visibility Impairment in MANE-VU Class I Areas**

Facility Name	State	2002 SO <sub>2</sub> Total (tons) <sup>a</sup>	Primary Emissions Point Description	Point ID (Permit ID No.)	Design Capacity	Existing Control(s)	Proposed/Planned Control(s)	Additional Information
Morgantown <sup>14, 15</sup>	MD	32,587	Combustion Engineering, Inc., Unit Boiler No. 2 - steam generating coal-fired utility boiler installed in 1967 primarily combusts Eastern Bituminous coal w/ no more than 2% sulfur by weight and secondary fuel is No. 6 oil w/ no more than 2% sulfur by weight	1 (F-2)	5,317 MMBTU/hr	ESP SO <sub>3</sub> injection Low NO <sub>x</sub> burners	SCR and FGD (2009/2010 timeframe)	Stacks equipped with SO <sub>2</sub> , NO <sub>x</sub> , CO <sub>2</sub> , and ultrasonic flow monitors. Unit covered under the MD Healthy Air Act.
Brayton Point <sup>19</sup>	MA	19,451	Water tube boiler	3 (EU3)	5,655 MMBTU/hr	ESP w/flue gas conditioning (PCD-3)	Fuel sulfur content (2011) FGD (2011)	BART recommended controls for SO <sub>2</sub> are 95% control or 0.15 lb/MMBTU (coal), 0.33 lb/MMBTU (0.3% fuel sulfur limit) (oil)
B L England <sup>20, 21</sup>	NJ	10,080	Wet-bottom, cyclone coal boiler	1	129 MW	ESP SNCR	None	The facility will either close by 2012 or install scrubbers on all coal-fired units. One scrubber is already installed and the other unit would get a 95% CE -minimum, but unclear if this unit is already controlled.

<sup>a</sup> 2002 SO<sub>2</sub> total for the emission point from RPO emission inventory.

- <sup>1</sup> Tennessee Department of Environment and Conservation, Division of Air Pollution Control. Personal communication regarding Johnsonville facility from Ms. Julie Aslinger (615-532-0587, [Julie.Aslinger@state.tn.us](mailto:Julie.Aslinger@state.tn.us)) via E-mail on March 1, 2007.
- <sup>2</sup> MACTEC Federal Programs, Inc., "Revised Draft Final, Assessing Reasonable Progress for Regional Haze in the Mid-Atlantic North Eastern Class I Areas", March 8, 2007. Comment regarding Johnsonville facility received from Ms. Julie Aslinger (615-532-0587, [Julie.Aslinger@state.tn.us](mailto:Julie.Aslinger@state.tn.us)) via E-mail on March 30, 2007.
- <sup>3</sup> MACTEC, Inc., "Documentation of the Base G 2002 Base Year, 2009 and 2018 Emission Inventories for VISTAS", January, 2007.
- <sup>4</sup> Ohio Environmental Protection Agency, Division of Air Pollution Control. Personal communications regarding Conesville facility from Mr. William Spires (614-644-3618, [bill.spires@epa.state.oh.us](mailto:bill.spires@epa.state.oh.us)) via E-mail on February 20 and 21, 2007.
- <sup>5</sup> Pennsylvania Department of Environmental Protection, Bureau of Air Quality. Personal communications regarding Keystone, Hatfield's Ferry, and Montour facilities from Ms. Nancy Herb (717-783-9269, [nherb@state.pa.us](mailto:nherb@state.pa.us)) via E-mail on January 31 and February 7, 2007.
- <sup>6</sup> Ohio Environmental Protection Agency, Division of Air Pollution Control. Personal communication regarding Muskingum, Kyger Creek, Avon Lake, Cardinal, and WH Sammis facilities from Mr. William Spires (614-644-3618, [bill.spires@epa.state.oh.us](mailto:bill.spires@epa.state.oh.us)) via E-mail on February 20, 2007.
- <sup>7</sup> West Virginia Division of Air Quality. Personal communication regarding John E. Amos, Mitchell, and Fort Martin facilities from Ms. Laura Crowder (304-926-0499 Ext. 1247, [L.CROWDER@wvdep.org](mailto:L.CROWDER@wvdep.org)) via E-mail on February 17, 2007.
- <sup>8</sup> MACTEC Federal Programs, Inc., "Revised Draft Final, Assessing Reasonable Progress for Regional Haze in the Mid-Atlantic North Eastern Class I Areas", March 8, 2007. Comments regarding John E. Amos, Mitchell, and Fort Martin and facilities received from Ms. Laura Crowder (304-926-0499 Ext. 1247, [LCROWDER@wvdep.org](mailto:LCROWDER@wvdep.org)) via E-mail on March 30, 2007.
- <sup>9</sup> Indiana Department of Environmental Management, Office of Air Quality. Personal communication regarding Wabash facility between Mr. Jay Koch (317-233-0581, [JKOCH@idem.IN.gov](mailto:JKOCH@idem.IN.gov)) and Ms. Lori Cress, MACTEC Federal Programs, Inc. on January 31, 2007.
- <sup>10</sup> Indiana Department of Environmental Management, Office of Air Quality. Personal communications regarding Wabash facility from Mr. Jay Koch (317-233-0581, [JKOCH@idem.IN.gov](mailto:JKOCH@idem.IN.gov)) via E-mail on February 1 and 5, 2007.
- <sup>11</sup> North Carolina Department of Environment and Natural Resources, Division of Air Quality. Personal communications regarding Belews Creek facility from Ms. Sheila Holman (919-715-0971, [sheila.holman@ncmail.net](mailto:sheila.holman@ncmail.net)) via E-mail on February 1 and 2, 2007.
- <sup>12</sup> MACTEC Federal Programs, Inc., "Revised Draft Final, Assessing Reasonable Progress for Regional Haze in the Mid-Atlantic North Eastern Class I Areas", March 8, 2007. Comments regarding Mitchell and Cardinal facilities received from Mr. David J. Long, P.E. of American Electric Power (614-716-1245, [djlong@aep.com](mailto:djlong@aep.com)) via E-mail on March 29, 2007.
- <sup>13</sup> Pennsylvania Department of Environmental Protection, Bureau of Air Quality. Personal communications regarding Homer City facility from Ms. Nancy Herb (717-783-9269, [nherb@state.pa.us](mailto:nherb@state.pa.us)) via E-mail on January 31 and February 7 and 8, 2007.
- <sup>14</sup> Maryland Department of the Environment. Personal communication regarding Chalk Point and Morgantown facilities from Mr. Andy Heltibridle (410-537-4218, [aheltibridle@mde.state.md.us](mailto:aheltibridle@mde.state.md.us)) via U.S. mail on February 9, 2007.
- <sup>15</sup> MACTEC Federal Programs, Inc., "Revised Draft Final, Assessing Reasonable Progress for Regional Haze in the Mid-Atlantic North Eastern Class I Areas", March 8, 2007. Comments regarding Chalk Point and Morgantown facilities received from Mr. Brian Hug (410-537-4125, [bhug@mde.state.md.us](mailto:bhug@mde.state.md.us)) via E-mail on March 14, 2007.
- <sup>16</sup> Michigan Department of Environmental Quality, Air Quality Division. Personal communication regarding Monroe facility from Ms. Teresa Walker (517-335-2247, [walkertr@michigan.gov](mailto:walkertr@michigan.gov)) via E-mail on February 7, 2007.
- <sup>17</sup> Virginia Department of Environmental Quality, Division of Air Quality. Personal communication regarding Chesterfield facility from Ms. Doris McLeod (504-698-4197, [dancleod@deq.virginia.gov](mailto:dancleod@deq.virginia.gov)) via E-mail on February 9, 2007.
- <sup>18</sup> Allegheny County Health Department. Personal communications regarding Cheswick facility from Ms. Jayme Graham (412-578-8129, [JGraham@achd.net](mailto:JGraham@achd.net)) via E-mail on February 2, 2007.
- <sup>19</sup> Massachusetts Department of Environmental Protection. Personal communications regarding Brayton Point facility from Mr. Donald Squires (617-292-5618, [Donald.Squires@state.ma.us](mailto:Donald.Squires@state.ma.us)) via E-mail on February 2 and 7, 2007.
- <sup>20</sup> New Jersey Department of Environmental Protection, Division of Air Quality. Personal communications regarding B.L. England facility between Mr. Ray Papalski (609-633-7225, [Ray.Papalski@dep.state.nj.us](mailto:Ray.Papalski@dep.state.nj.us)) and Ms. Lori Cress, MACTEC Federal Programs, Inc. on January 31, 2007.
- <sup>21</sup> New Jersey Department of Environmental Protection, Division of Air Quality. Personal communications regarding B.L. England facility from Mr. Ray Papalski (609-633-7225, [Ray.Papalski@dep.state.nj.us](mailto:Ray.Papalski@dep.state.nj.us)) via E-mail on February 1, 2007.

Table 3.3 presents a side by side comparison of the predicted control information from Tables 3.1 and 3.2. The existing control information available from Integrated Planning Model (IPM<sup>®</sup>) data was in disagreement with the information reported by the States for many of the EGUs. Since controls at the EGUs may have changed recently [since Integrated Planning Model (IPM<sup>®</sup> v.2.1.9)], Table 3.3 reports existing control information obtained from the States for this report. The information on proposed or planned controls obtained from the States reflects that 26 of the 30 EGUs included in this study plan to install SO<sub>2</sub> control (FGD/scrubber), or switch to a lower sulfur coal prior to 2018. SO<sub>2</sub> reduction estimates from the States were only available for some of the EGUs, but reflect a significant reduction in SO<sub>2</sub> for those units for which an estimate was supplied.

Regarding the control information from Integrated Planning Model (IPM<sup>®</sup>) CAIR Plus results, Integrated Planning Model (IPM<sup>®</sup>) predicts that 21 of the 30 EGUs will install SO<sub>2</sub> in the CAIR Plus scenario. Additionally, Integrated Planning Model (IPM<sup>®</sup>) predicts a reduction in SO<sub>2</sub> at all 30 EGUs included in this study, including the 9 units for which no SO<sub>2</sub> control is added. The SO<sub>2</sub> reductions estimated by Integrated Planning Model (IPM<sup>®</sup>) are said to be achieved through a number of compliance strategies in addition to control, such as fuel switching, plant retirements, plant dispatch, and new builds. Additional information on all Integrated Planning Model (IPM<sup>®</sup>) compliance strategies and well as information on NO<sub>x</sub> reductions are available in Integrated Planning Model (IPM<sup>®</sup>) documentation available on EPA's website and in the ICF report titled: *Final Draft Report – Comparison of CAIR and CAIR Plus Proposal Using the Integrated Planning Model (IPM<sup>®</sup>)*.

**Table 3.3 Comparison of Controls Predicted by Integrated Planning Model (IPM<sup>®</sup>) CAIR Plus Results versus Proposed/Planned Control Additions by the State/Facility (by 2018) at the Top 30 EGUs Responsible for Visibility Impairment in MANE-VU Class I Areas**

Facility Name	State	Point #	2002 SO <sub>2</sub> (tons)	Existing Controls (based on information from State)	Facility/State Proposed/Planned Controls { % SO <sub>2</sub> reduction }	IPM <sup>®</sup> Predicted Controls (CAIR Plus) { % SO <sub>2</sub> reduction }
Johnsonville	TN	10	108,789	ESP	Low sulfur fuel since 2002; SCR by 2018 {53% reduction in SO <sub>2</sub> }	SCR by 2012 {58% reduction in SO <sub>2</sub> }
Conesville	OH	4	92,340	ESP	FGD and SCR by 8/18/09 {SO <sub>2</sub> reduction unavailable}	SCR and Scrubber by 2009 {92% reduction in SO <sub>2</sub> }
Keystone	PA	1	87,709	Cold-side ESP; SCR	FGD {SO <sub>2</sub> reduction unavailable}	Scrubber by 2009 {94% reduction in SO <sub>2</sub> }
Muskingum River	OH	4	24,484	ESP	None planned {SO <sub>2</sub> reduction assumed 0%}	SCR and Scrubber by 2012 {96% reduction in SO <sub>2</sub> }
Hatfield's Ferry	PA	1	55,695	Cold-side ESP	FGD {SO <sub>2</sub> reduction unavailable}	None {77% reduction in SO <sub>2</sub> }
Kyger Creek	OH	1	13,789	ESP	SCR, FGD operational by 1/01/09 {SO <sub>2</sub> reduction unavailable}	Scrubber by 2012 {93% reduction in SO <sub>2</sub> }
John E. Amos	WV	2	31,465	ESP; Low NO <sub>x</sub> burners; SCR	FGD by 12/2008 {SO <sub>2</sub> reduction unavailable}	Scrubber {81% reduction in SO <sub>2</sub> }

**Table 3.3 Comparison of Controls Predicted by Integrated Planning Model (IPM<sup>®</sup>) CAIR Plus Results versus Proposed/Planned Control Additions by the State/Facility (by 2018) at the Top 30 EGUs Responsible for Visibility Impairment in MANE-VU Class I Areas**

Facility Name	State	Point #	2002 SO <sub>2</sub> (tons)	Existing Controls (based on information from State)	Facility/State Proposed/Planned Controls { % SO <sub>2</sub> reduction }	IPM <sup>®</sup> Predicted Controls (CAIR Plus) { % SO <sub>2</sub> reduction }
Keystone	PA	2	62,890	Cold-side ESP; SCR	FGD {SO <sub>2</sub> reduction unavailable}	Scrubber by 2009 {94% reduction in SO <sub>2</sub> }
Wabash River	IN	5	9,380	Low NO <sub>x</sub> burners; ESP	None planned {SO <sub>2</sub> reduction assumed 0%}	SNCR by 2009 {89% reduction in SO <sub>2</sub> }
Montour	PA	1	61,005	Cold-side ESP; SCR	FGD {SO <sub>2</sub> reduction unavailable}	Scrubber by 2009 {93% reduction in SO <sub>2</sub> }
Belews Creek	NC	1	57,848	None	Scrubbers (2008) {90% reduction in SO <sub>2</sub> }	Mercury control {95% reduction in SO <sub>2</sub> }
Mitchell	WV	2	29,532	ESP; Low NO <sub>x</sub> burners	FGD (1/2007); SCR (4/2007) {SO <sub>2</sub> reduction unavailable}	None {80% reduction in SO <sub>2</sub> }
Homer City	PA	2	55,346	Cold-side ESP; SCR	FGD {SO <sub>2</sub> reduction unavailable}	Scrubber by 2009 {95% reduction in SO <sub>2</sub> }
Montour	PA	2	50,441	Cold-side ESP; SCR	FGD {SO <sub>2</sub> reduction unavailable}	Scrubber by 2009 {92% reduction in SO <sub>2</sub> }
Chalk Point	MD	2	23,537	Low NO <sub>x</sub> burners; ESP; SACR LNBs & SOFA	SCR and FGD (2009/2010 timeframe) {SO <sub>2</sub> reduction unavailable}	SCR and Scrubber by 2009 {92% reduction in SO <sub>2</sub> }
Monroe	MI	1 & 2	48,563	Dry wire ESP; FGD	Possible addition of scrubbers {97% SO <sub>2</sub> reduction if controlled}	None {42% reduction in SO <sub>2</sub> }
Homer City	PA	1	45,745	Cold-side ESP; SCR	FGD {SO <sub>2</sub> reduction unavailable}	Scrubber by 2009 {93% reduction in SO <sub>2</sub> }
Belews Creek	NC	2	45,236	None	Scrubbers (2008) {90% reduction in SO <sub>2</sub> }	Mercury control {93% reduction in SO <sub>2</sub> }
Fort Martin	WV	2	45,890	ESP, Low NO <sub>x</sub> burners; SNCR Trim	FGD (4Q 2009) {SO <sub>2</sub> reduction unavailable}	Scrubber by 2012 {89% reduction in SO <sub>2</sub> }
Fort Martin	WV	1	45,228	ESP, Low NO <sub>x</sub> burners; SNCR Trim	FGD (1Q 2010) {SO <sub>2</sub> reduction unavailable}	Scrubber by 2012 {89% reduction in SO <sub>2</sub> }
John E. Amos	WV	3	44,030	ESP, Low NO <sub>x</sub> burners; SCR	FGD (12/2007) {SO <sub>2</sub> reduction unavailable}	Scrubber {80% reduction in SO <sub>2</sub> }
Avon Lake	OH	12	41,872	ESP	SCR and FGD operational by 2010 {SO <sub>2</sub> reduction unavailable}	Scrubber by 2009; SCR by 2012 {86% reduction in SO <sub>2</sub> }
Chesterfield	VA	6	40,923	SCR; ESP; Stage combustion burners	FGD operational 2008 {95% reduction in SO <sub>2</sub> }	SCR and Scrubber by 2012 {90% reduction in SO <sub>2</sub> }
Cheswick	PA	1	42,018	Low NO <sub>x</sub> burners; SCR; ESP w/flue gas conditioning	None {SO <sub>2</sub> reduction assumed 0%}	Scrubber by 2009 {88% reduction in SO <sub>2</sub> }
Cardinal	OH	1	39,894	ESP	FGD (2/2008) {SO <sub>2</sub> reduction unavailable}	Scrubber by 2012 {95% reduction in SO <sub>2</sub> }

**Table 3.3 Comparison of Controls Predicted by Integrated Planning Model (IPM<sup>®</sup>) CAIR Plus Results versus Proposed/Planned Control Additions by the State/Facility (by 2018) at the Top 30 EGUs Responsible for Visibility Impairment in MANE-VU Class I Areas**

Facility Name	State	Point #	2002 SO <sub>2</sub> (tons)	Existing Controls (based on information from State)	Facility/State Proposed/Planned Controls { % SO <sub>2</sub> reduction }	IPM <sup>®</sup> Predicted Controls (CAIR Plus) { % SO <sub>2</sub> reduction }
Morgantown	MD	1	37,757	ESP; SO <sub>3</sub> injection; Low NO <sub>x</sub> burners	SCR and FGD (2009/2010 timeframe) {SO <sub>2</sub> reduction unavailable}	SCR and Scrubber by 2009 {92% reduction in SO <sub>2</sub> }
W H Sammis	OH	7	33,720	Fabric filter	ESP and FGD operational 12/31/09; SNCR operational 6/06 {SO <sub>2</sub> reduction unavailable}	Scrubber in 2009; Coal to IGCC in 2012 {91% reduction in SO <sub>2</sub> }
Morgantown	MD	2	32,587	ESP; SO <sub>3</sub> injection; Low NO <sub>x</sub> burners	SCR and FGD (2009/2010 timeframe) {SO <sub>2</sub> reduction unavailable}	SCR and Scrubber by 2009 {91% reduction in SO <sub>2</sub> }
Brayton Point	MA	3	19,451	ESP w/flue gas conditioning (PCD-3)	Fuel sulfur content (2011); FGD 2011 {95% reduction in SO <sub>2</sub> }	SCR, Scrubber, Mercury Control by 2009 {85% reduction in SO <sub>2</sub> }
B L England	NJ	1	10,080	ESP;SNCR	Facility will either close or install scrubbers by 2012 {95% reduction in SO <sub>2</sub> }	None {90% reduction in SO <sub>2</sub> }

Table Reference: See full reference information for Integrated Planning Model (IPM<sup>®</sup>) and State agency contacts associated with Tables 3.1 and 3.2.

## REFERENCES

2002 MANE-VU Emissions Inventory Version 3.

NESCAUM. *Assessment of Control Technology Options for BART-Eligible Sources*; March, 2005.

Midwest RPO. *Candidate Control Measures – Source Category: Electric Generating Units*; 12/09/2005.

STAPPA-ALAPCO. *Controlling Fine Particulate Matter Under the Clean Air Act: A Menu of Options*; March 2006.

Evans, David A; Hobbs, B.F.; Oren, C.; Palmer, K.L. *Modeling the Effects of Changes in New Source Review on National SO<sub>2</sub> and NO<sub>x</sub> Emissions from Electricity-Generating Units*.

ICF Resources. *Final Draft Report - Comparison of CAIR and CAIR Plus Proposal Using the Integrated Planning Model (IPM<sup>®</sup>)*, May 30, 2007.

U.S. EPA. EPA-600/R-05/034; *Multipollutant Emission Control Technology Options for Coal-fired Power Plants*; March 2005.

U.S. EPA. Integrated Planning Model (IPM<sup>®</sup>) background documentation located on website: (<http://www.epa.gov/airmarkets/progsregs/epa-ipm/past-modeling.html>)

Energy Information Administration (EIA). Information located on website: <http://www.eia.doe.gov/cneaf/coal/page/coalnews/coalmar.html>

Energy Information Administration (EIA). Information located on website: <http://www.eia.doe.gov/cneaf/coal/page/acr/table31.html>

World Bank Organization. Information located on website: <http://www.worldbank.org/html/fpd/em/power/EA/mitigatn/aqsocc.stm>



**Attachment 1. Illustrative Scrubber Costs (1999 \$) for Representative MW and Heat Rates  
 under the Assumptions in EPA Base Case 2004**

Scrubber Type	Capacity (MW)	Heat Rate (BTU/kWh)			Cost
		9,000	10,000	11,000	
LSFO  Min. Cutoff: >= 100 MW Max. Cutoff: None  Assuming 3.0% Sulfur Content Coal (by weight) with Heating Value of 11,900 BTU/lb	100	456	469	481	Cap.Cost (\$/kW)
		19	19	20	Fix. O&M \$/kW-yr
		1.6	1.7	1.9	Var. O&M mills/kWh
	300	225	234	243	Cap.Cost (\$/kW)
		11	11	20	Fix. O&M \$/kW-yr
		1.6	1.7	1.9	Var. O&M mills/kWh
	500	173	180	187	Cap.Cost (\$/kW)
		9	9	9	Fix. O&M \$/kW-yr
		1.6	1.7	1.9	Var. O&M mills/kWh
	700	142	149	155	Cap.Cost (\$/kW)
		8	8	8	Fix. O&M \$/kW-yr
		1.6	1.7	1.9	Var. O&M mills/kWh
	1,000	157	166	174	Cap.Cost (\$/kW)
		7	8	8	Fix. O&M \$/kW-yr
		1.6	1.7	1.9	Var. O&M mills/kWh
MEL  Min. Cutoff: >= 100 MW Max. Cutoff: <500 MW  Assuming 1.5% Sulfur Content Coal (by weight) with Heating Value of 11,900 BTU/lb	100	340	351	362	Cap.Cost (\$/kW)
		17	17	17	Fix. O&M \$/kW-yr
		0.8	0.9	1	Var. O&M mills/kWh
	200	224	233	241	Cap.Cost (\$/kW)
		12	12	12	Fix. O&M \$/kW-yr
		0.8	0.9	1	Var. O&M mills/kWh
	300	224	235	245	Cap.Cost (\$/kW)
		11	11	12	Fix. O&M \$/kW-yr
		0.8	0.9	1	Var. O&M mills/kWh
	400	200	210	220	Cap.Cost (\$/kW)
		10	10	10	Fix. O&M \$/kW-yr
		0.8	0.9	1	Var. O&M mills/kWh
	500	178	187	196	Cap.Cost (\$/kW)
		9	9	9	Fix. O&M \$/kW-yr
		0.8	0.9	1	Var. O&M mills/kWh
LSD  Min. Cutoff: >= 550 MW Max. Cutoff: None  Assuming 1.5% Sulfur Content Coal (by weight) with Heating Value of 11,900 BTU/lb	600	137	144	151	Cap.Cost (\$/kW)
		5	5	6	Fix. O&M \$/kW-yr
		1.6	1.8	2	Var. O&M mills/kWh
	700	127	134	140	Cap.Cost (\$/kW)
		5	5	5	Fix. O&M \$/kW-yr
		1.6	1.8	2	Var. O&M mills/kWh
	800	124	130	135	Cap.Cost (\$/kW)
		5	5	5	Fix. O&M \$/kW-yr
		1.6	1.8	2	Var. O&M mills/kWh
	900	125	131	137	Cap.Cost (\$/kW)
		4	4	4	Fix. O&M \$/kW-yr
		1.6	1.8	2	Var. O&M mills/kWh
	1,000	118	124	130	Cap.Cost (\$/kW)
		4	4	4	Fix. O&M \$/kW-yr
		1.6	1.8	2	Var. O&M mills/kWh

Table reference: Copy of Table 5.3 from EPA Integrated Planning Model (IPM<sup>®</sup>) documentation (<http://www.epa.gov/airmarkets/progregrs/epa-ipm/docs/bc5emission.pdf>). (Note: To adjust cost data from 1999 to 2006, multiply by 1.2101 [www.inflationdata.com](http://www.inflationdata.com))

**Attachment 2. Engineering Methodology Used to Calculate \$/ton Pollutant Reduction**

Calculation of Cost per ton of SO2 of scrubbing  
 First, calculate annual cost of a scrubber (\$/kW/yr)

Cost data

Cap	Fix O&M	Var O&M
469	19	1.7
\$/Kw	\$/KW-yr	\$/KWh

Assume

Cap Rec Factor	CapacFact
0.15	0.85
1/yr	dimensionless
	8760 hr/yr

Implies 

70.35	19	12.6582	102.01
\$/KW-yr	\$/KW-yr	\$/KW-yr	\$/KW-yr

 This is the annual cost per kW for a scrubber

Then calculation annual emissions reduction from the scrubber

Calculate emissions rate (lb/MBTU) based on coal S content

Fraction S	SO2/S	Heat Content	SO2 Emissions rate
3%	2	0.012	5
dimensionless	dimensionless	MBTU/lb	lb/MBTU

divided by =

Use emissions rate and assumed plant efficiency/operating hours to get emissions/kw/yr

UnconSO2 Reduction	Heat Rate	Cap Factor	Hr/yr	tons/lb	=	0.167535
0.9	0.01	0.85	8760	0.0005		tons/kw-yr
lb/MBTU	dimensionless	MBTU/kWh	dimensionless	hr/yr		tons/lb

Check of units

lb	mbtu	hr	ton
mbtu	kw-hr	yr	lb

Result: Get \$/ton of reduction

divide cost/kw/yr by ton/kw/yr = 

608.877
---------

 = 102.01 divided by 0.167535

\$/KW-yr tons/kw-yr

## CHAPTER 4

### SOURCE CATEGORY ANALYSIS: INDUSTRIAL, COMMERCIAL, AND INSTITUTIONAL BOILERS

#### SOURCE CATEGORY DESCRIPTION

The MANE-VU contribution assessment has demonstrated that SO<sub>2</sub> emissions are the principal contributor to visibility impairment in Class I areas in the northeast. After electric generation units, Industrial, Commercial, and Institutional (ICI) boilers and heaters are the next largest class of pollution sources that contribute to SO<sub>2</sub> emissions. Typical industrial applications include chemical, refining, manufacturing, metals, paper, petroleum, food production and a wide variety of other small industries and commercial heating applications. Commercial and institutional boilers are normally used to produce steam and hot water for space heating in office buildings, hotels, apartment buildings, hospitals, universities, and similar facilities. Most commercial and institutional boilers are small, with 80% of the population smaller than 15 million British Thermal Units per hour (MMBTU/hr). A fairly wide range of fuels are used by ICI boilers, ranging from coal, petroleum coke, distillate and residual fuel oils, natural gas, wood waste or other class of waste products. Boilers aggregated under the ICI classification are generally smaller than boilers in the electric power industry, and typically have a heat input in the 10 to 250 MMBTU/hr range; however, industrial boilers can be as large as 1,000 MMBTU/hr or as small as 0.5 MMBTU/hour.

The process that a particular unit serves strongly influences the boiler fuel choice. For example, the iron and steel industry uses coal to generate blast furnace gas or coke oven gas that is used in boilers, resulting in sulfur emissions. Pulp and paper processing may use biomass as a fuel, resulting in high PM emissions. Units with short duty cycles may utilize oil or natural gas as a fuel. The use of a wide variety of fuels is an important characteristic of the ICI boiler category. While many boilers are capable of co-firing liquid or gaseous fuels in conjunction with solid fuels, boilers are usually designed for optimum combustion of a single specific, fuel. Changes to the fuel type may, therefore, reduce the capacity, duty cycle, or efficiency of the boiler.

Boiler design also plays a role in the uncontrolled emission rate. Most ICI boilers are of three basic designs: water tube, fire tube, or cast iron. The fuel-firing configuration is a second major identifier of boiler design for solid fuels. Stoker boilers are the oldest technology and are still widely used for solid-fueled boilers. Pulverized coal boilers succeeded stokers as a more efficient method of burning coal and are used in larger boiler designs. Circulating fluidized bed (CFB) boilers are the most recent type of boiler for solid fuel combustion and are becoming more commonplace. CFB boilers are capable of burning a variety of fuels, and are more efficient and less polluting than stoker or pulverized coal boilers. Combined heat and power (CHP) or cogeneration technologies are also used to produce electricity and steam or hot water from a single unit. Some ICI boilers are used only in the colder months for space heating, while others have high capacity utilization year round.

### **Clean Air Act Regulations Controlling ICI Boilers**

Emissions from ICI boilers are currently governed by multiple State and federal regulations under the Titles I, III, and IV of the Clean Air Act. Each of these regulatory programs is discussed in the following paragraphs. Title I regulates criteria pollutants by requiring local governments to adopt State Implementation Plans (SIPs) that set forth their strategy for achieving reductions in the particular criteria pollutant(s) for which they are out of attainment. The SIP requirements includes Reasonably Available Control Technology (RACT) requirements, but more stringent requirements may be imposed depending on the locale's degree of non-attainment with ambient air standards.

Title I also imposes New Source Performance Standards (NSPS) on certain specified categories of new and modified large stationary sources. In 1986, EPA codified the NSPS for industrial boilers (40 CFR part 60, subparts Db and Dc) and revised portions of them in 1998 to reflect improvements in control methods for the reduction of NO<sub>x</sub> emissions. Subpart Db applies to fossil fuel-fired ICI units greater than 100 MMBTU per hour that were constructed or modified after June 19, 1984. Subpart Dc applies to fossil fuel-fired ICI units from 10 to 100 MMBTU per hour that were constructed or modified after June 9, 1989.

In addition, Title I subjects new and modified large stationary sources that increase their emissions to permitting requirements that impose control technologies of varying levels of stringency (known as New Source Review, or NSR). NSR prescribes control technologies for new plants and for plant modifications that result in a significant increase in emissions, subjecting them to Best Available Control Technology (BACT) in attainment areas and to the Lowest Achievable Emission Rate (LAER) in non attainment areas. Control strategies that constitute BACT and LAER evolve over time and are reviewed on a case by case basis in State permitting proceedings.

On September 13, 2004, EPA published a final rule under Title III of the CAA to substantially reduce emissions of toxic air pollutants from ICI boilers. These Maximum Achievable Control Technology (MACT) standards apply to ICI boilers located at major sources of hazardous air pollutants (HAPs). There are many options for complying with the MACT standards, ranging from continued use of existing control systems to fuel switching to the installation of a fabric filter and wet scrubber technologies. Thus, the control technologies used to reduce the level of HAP emitted from affected sources are also expected to reduce emissions of PM, and to a lesser extent, SO<sub>2</sub> emissions.

Title IV of the CAA addresses acid rain by focusing primarily on power plant emissions of SO<sub>2</sub>. Title IV includes an Opt-in Program that allows sources not required to participate in the Acid Rain Program the opportunity to enter the program on a voluntary basis and receive their own acid rain allowances. The Opt-in Program offers sources such as ICI boilers a financial incentive to voluntarily reduce its SO<sub>2</sub> emissions. By reducing emissions below allowance allocation, an opt-in source will have unused allowances, which it can sell in the SO<sub>2</sub> allowance market.

The regulation of ICI boilers by various CAA programs has resulted in a variety of unit level emission limits resulting from SIP, NSPS, NSR, or MACT requirements. Overlaid on these unit level requirements are system-wide allowances of the NO<sub>x</sub> SIP call and the Acid Rain SO<sub>2</sub> opt-in

program. Thus, the specific emission limits and control requirements for a given ICI boiler vary and depend on boiler age, size, and geographic location.

## EVALUATION OF CONTROL OPTIONS

An undesirable by-product of the combustion of sulfur, SO<sub>2</sub> is associated with the combustion of most fossil fuels. Coal deposits contain sulfur in amounts ranging from trace quantities to as high as 8% or more. Distillate oils typically have sulfur contents less than 0.5% while residual oil can have 1-2% sulfur by weight. Petroleum coke, a byproduct of the oil refining process, may have as much as 6% sulfur. Pipeline quality natural gas contains virtually no sulfur, while landfill gas may contain varying amounts of sulfur depending on the materials contained in the landfill. A variety of air pollution control technologies are employed to meet requirements for sulfur dioxide control and are dependant on a number of factors to determine which technique is utilized for a given facility.

Air pollution reduction and control technologies for ICI boilers have advanced substantially over the past 25 years. In addition, advances in power generation technologies, renewable energy, and energy efficiency have the potential to further reduce emissions from these facilities. The focus of this evaluation is on the first category mentioned above - emission control technologies. The timing and magnitude of reductions from the other strategies – improved technologies, demand reduction/energy efficiency, and clean power should be considered as part of a longer-term solution.

Control techniques may be classified into three broad categories: fuel treatment/substitution, combustion modification, and post-combustion control. Fuel treatment primarily reduces SO<sub>2</sub> and includes coal cleaning using physical, chemical, or biological processes. Fuel substitution involves burning a cleaner fuel or renewable fuel. Combustion modification includes any physical or operational change in the furnace or boiler and is sometimes discussed in conjunction with post-combustion control technologies. Post-combustion control employs a device after the combustion of the fuel and is applied to control emissions of SO<sub>2</sub>. It should be noted that physical or operational changes to a furnace or boiler may require that the unit be examined for applicability under the Prevention of Significant Deterioration (PSD) program.

There are a wide variety of proven control technologies for reducing SO<sub>2</sub> emissions from ICI boilers. The method of SO<sub>2</sub> control appropriate for any individual ICI boiler is dependent upon the type of boiler, type of fuel, capacity utilization, and the types and staging of other air pollution control devices. However, cost effective emissions reduction technologies for SO<sub>2</sub> are available and are effective in reducing emissions from the exhaust gas stream of ICI boilers.

Effective post-combustion SO<sub>2</sub> controls for boilers, and particularly coal-fired boilers, are well understood and have been applied to a number of sources over the years in response to regulations in the form of NSPS, PSD/NSR, State RACT Rules and the Title IV SO<sub>2</sub> program. Additional SO<sub>2</sub> reductions are anticipated as a result of regional pollution control initiatives prompted by the Clean Air Interstate Rule (CAIR), which was passed on May 12, 2005.

In addition to post-combustion controls that can be applied to reduce emissions of SO<sub>2</sub> from fossil fuel fired boilers, there are other strategies that can be used to reduce emissions of SO<sub>2</sub>.

Examples of such strategies include switching to a fuel with a lower sulfur content, or coal cleaning prior to combustion. Methods of SO<sub>2</sub> control applicable to ICI boilers are listed in Table 4.1 with a brief description of the control option, applicability, and range of performance. After the table, a more detailed description of the control option and an analysis of the four factor assessment for reasonable progress is presented.

### **SO<sub>2</sub> Control Option Descriptions**

Almost all SO<sub>2</sub> emission control technologies fall in the category of reducing SO<sub>2</sub> after its formation, as opposed to minimizing its formation during combustion. The exception to the nearly universal use of post-combustion controls is found in fuel switching and, more significantly, in fluidized bed boilers, in which limestone is added to the fuel in the combustion chamber.

Post-combustion SO<sub>2</sub> control is accomplished by reacting the SO<sub>2</sub> in the gas with a reagent (usually calcium- or sodium-based) and removing the resulting product (a sulfate/sulfite) for disposal or commercial use depending on the technology used. SO<sub>2</sub> reduction technologies are commonly referred to as Flue Gas Desulfurization (FGD) and are usually described in terms of the process conditions (wet versus dry), byproduct utilization (throwaway versus saleable) and reagent utilization (once-through versus regenerable).

Within each technology category, multiple variations are possible and typically involve the type and preparation of the reagent, the temperature of the reaction (for dry processes), the use of enhancing additives, etc. Because these variations mostly involve complex process chemistry, but are fundamentally similar, this summary focuses on the major categories of SO<sub>2</sub> control technologies, their applicability, performance and cost. Descriptions of available SO<sub>2</sub> control technology options are in Table 4.1. A brief discussion of these techniques follows.

**Table 4.1 Available SO<sub>2</sub> Control Options For ICI Boilers**

<b>Technology</b>	<b>Description</b>	<b>Applicability</b>	<b>Performance</b>
Switch to a Low Sulfur Coal (generally <1% sulfur)	Replace high-sulfur bituminous coal combustion with lower-sulfur coal	Potential control measure for all coal-fired ICIs currently using coal with high sulfur content	50-80% reduction in SO <sub>2</sub> emissions by switching to a lower-sulfur coal
Switch to Natural Gas (virtually 0% sulfur)	Replace coal combustion with natural gas	Potential control measure for all coal-fired ICIs	Virtually eliminate SO <sub>2</sub> emissions by switching to natural gas
Switch to a Lower Sulfur Oil	Replace higher-sulfur residual oil with lower-sulfur distillate oil. Alternatively, replace medium sulfur distillate oil with ultra-low sulfur distillate oil	Potential control measure for all oil-fired ICIs currently using higher sulfur content residual or distillate oils	50-80% reduction in SO <sub>2</sub> emissions by switching to a lower-sulfur oil
Coal Cleaning	Coal is washed to remove some of the sulfur and ash prior to combustion	Potential control measure for all coal-fired ICI boilers	20-25% reduction in SO <sub>2</sub> emissions
Combustion Control	A reactive material, such as limestone or bi-carbonate, is introduced into the combustion chamber along with the fuel	Applicable to pulverized coal-fired boilers and circulating fluidized bed boilers	40%-85% reductions in SO <sub>2</sub> emissions
Flue Gas Desulfurization (FGD) - Wet	SO <sub>2</sub> is removed from flue gas by dissolving it in a lime or limestone slurry. (Other alkaline chemicals are sometimes used)	Applicable to all coal-fired ICI boilers	30-95%+ reduction in SO <sub>2</sub> emissions
Flue Gas Desulfurization (FGD) – Spray Dry	A fine mist containing lime or other suitable sorbent is injected directly into flue gas	Applicable primarily for boilers currently firing low to medium sulfur fuels	60-95%+ reduction in SO <sub>2</sub> emissions
Flue Gas Desulfurization (FGD) –Dry	Powdered lime or other suitable sorbent is injected directly into flue gas	Applicable primarily for boilers currently firing low to medium sulfur fuels	40-60% reduction in SO <sub>2</sub> emissions

Table references:

1. *Assessment of Control Technology Options for BART-Eligible Sources*, NESCAUM, March 2005.
2. *Controlling Fine Particulate Matter Under the Clean Air Act: A Menu of Options*, STAPPA-ALAPCO, March 2006.

### Switch to Coal with Lower Sulfur Content

Switching from a high sulfur fuel to one with sufficiently low sulfur content is the first option available for SO<sub>2</sub> reduction in this category for pre-combustion control of SO<sub>2</sub>. Fuels naturally low in sulfur content are readily available for solid (coal) and liquid (oil) fired boilers. For coal-fired boilers, low-sulfur fuels may be obtained directly or, alternatively, the sulfur content of coal fired in the boiler may be lowered first by cleaning the coal or blending coals obtained from several sources.

However, burning low-sulfur fuel may not be a technically feasible or economically practical SO<sub>2</sub> control alternative for all boilers. In some cases, a fuel with the required sulfur content to meet the applicable emission reduction may not be available or cannot be fired satisfactorily in a given boiler unit design. Even if such a fuel is available, use of the lower-sulfur fuel that must be transported long distances from the supplier may not be cost competitive with burning higher sulfur fuel supplied by near-by suppliers and using a post-combustion control device. The feasibility of fuel switching depends partly on the characteristics of the plant and the particular type of fuel change being considered. Many plants will be able to switch from high-sulfur to low-sulfur bituminous coal without serious difficulty, but switching from bituminous to sub-bituminous coal may present greater challenges and costs. In some instances, fuel switching will require significant investment and modifications to an existing plant. Switching to a lower sulfur fuel, either coal or oil, can affect fuel handling systems, boiler performance, PM control effectiveness and ash handling systems. Overall SO<sub>2</sub> reductions estimated from switching to low-sulfur fuels range from 50-80%.

### Switch to Natural Gas

Switching from coal combustion to natural gas combustion virtually eliminates SO<sub>2</sub> emissions. It is technically feasible to switch from coal to natural gas, but it is currently uneconomical to consider this option for large ICIs due to the fuel quantity necessary and the price of natural gas. The price of natural gas is roughly seven times the price of coal in terms of heating value.

### Reduced Sulfur Oil

Oil-fired boilers may opt for lower sulfur distillate fuels or, if available, ultra-low sulfur distillate fuel. Number 2 distillate fuel oil, heating oil, and highway diesel fuel oil are the same refinery-produced liquid, and are only differentiated for tax purposes. This differentiation is accomplished through addition of a red dye in the fuels supplied for non-transportation related use. Currently, the sulfur content in Number 2 oil varies between 15 and 20,000 ppm. Beginning in 2006, the permissible level of sulfur in highway diesel fuel (ultra low sulfur diesel, or ULSD) was reduced to 15 ppm. Prior to that, highway low sulfur diesel fuel was refined to contain 500 ppm sulfur (Low Sulfur Diesel, or LSD). Consequently, refineries have already performed the capital investments required for the production of LSD and ULSD fuel oil. Based on EIA data for the week of Feb 23, 2007 domestic production of ULSD fuel oil accounted for about 45% of all distillate oil in the United States and LSD fuel oil accounted for slightly over 17% of domestic production (See Chapter 8).



### Coal Cleaning

According to the 2006 STAPPA-ALAPCO document on control technologies titled *Controlling Particulate Matter Under the Clean Air Act: A Menu of Options*, coal cleaning or washing is a widely practiced method of reducing impurities in coal, particularly sulfur. Reducing the sulfur content of the fuel used in the boiler reduces the SO<sub>2</sub> emissions proportionally. Coal cleaning has been shown to reduce SO<sub>2</sub> emissions by 20-25%, while increasing the heating value of the fuel. Additional removal can be achieved through advanced chemical washing techniques, but no detailed information on these techniques was available.

Conventional (physical) coal washing techniques remove ash and sulfur from coal by crushing the fuel and separating the components in a liquid bath, such as water. The lighter coal particles float to the top of the bath for recovery, while the heavier impurities sink to the bottom for removal.

Although there are benefits associated with coal washing, there are limitations associated with this technology. The 20-25% SO<sub>2</sub> reduction is beneficial, but post-combustion controls have been shown to reduce SO<sub>2</sub> emissions by greater percentages. Also, solid and liquid wastes are generated using the washing process and must be addressed.

### Combustion Control

SO<sub>2</sub> reduction is also possible through combustion related control technologies. One such technology that has been demonstrated and is currently available is the use of fluidized bed boilers.

Fluidized bed boilers generally operate at lower temperatures than other combustion systems, 800° to 870° C (1500° F to 1600° F). The lower temperatures allow the use of limestone or dolomite to be added to the bed to capture sulfur. Limestone (CaCO<sub>3</sub>) is converted to CaO at approximately 800° C (1500° F). SO<sub>2</sub> released from the fuel reacts with CaO to form CaSO<sub>4</sub>, which is thermodynamically stable at bed temperatures. By recycling some of the solids leaving the bed up to 90% removal of SO<sub>2</sub> can be achieved with Ca/S molar ratios of 2 to 2.5 in circulating fluidized beds. Higher Ca/S ratios are required in bubbling beds. In either case, the sorbent is removed with the ash from the bed and sent to disposal.

### Flue Gas Desulfurization (FGD)

There are three types of FGD scrubbers: wet, spray dry, and dry. According to the 2006 STAPPA-ALAPCO document on control technologies titled *Controlling Particulate Matter Under the Clean Air Act: A Menu of Options*, EPA reports that 85% of the FGD systems in use in the United States are wet systems. Twelve percent of the FGD systems are spray dry systems, and 3% are dry systems. The operating parameters, efficiency, and costs of each SO<sub>2</sub> removal method are different.

SO<sub>2</sub> in the flue gas can be removed by reacting the sulfur compounds with a solution of water and an alkaline chemical to form insoluble salts that are removed in the scrubber effluent. These processes are called "wet FGD systems". Most wet FGD systems for control of SO<sub>2</sub> emissions

are based on using either limestone or lime as the alkaline source. At some of these facilities, fly ash is mixed with the limestone or lime. Several other scrubber system designs (e.g., sodium carbonate, magnesium oxide, dual alkali) are used by a small number of boilers.

The basic wet limestone scrubbing process is simple and is the type most widely used for control of SO<sub>2</sub> emissions from coal-fired electric utility boilers. Limestone sorbent is inexpensive and generally available throughout the United States. In a wet limestone scrubber, the flue gas containing SO<sub>2</sub> is brought into contact with limestone/water slurry. The SO<sub>2</sub> is absorbed into the slurry and reacts with limestone to form an insoluble sludge. The sludge, mostly calcium sulfite hemi-hydrate and gypsum, is disposed of in a pond specifically constructed for the purpose or is recovered as a salable byproduct.

The wet lime scrubber operates in a similar manner to the wet limestone scrubber. In a wet lime scrubber, flue gas containing SO<sub>2</sub> is contacted with hydrated lime/water slurry; the SO<sub>2</sub> is absorbed into the slurry and reacts with hydrated lime to form an insoluble sludge. The hydrated lime provides greater alkalinity (higher pH) and reactivity than limestone. However, lime-scrubbing processes require disposal of large quantities of waste sludge.

The SO<sub>2</sub> removal efficiencies of existing wet limestone scrubbers range from 31-97%, with an average of 78%. The SO<sub>2</sub> removal efficiencies of existing wet lime scrubbers range from 30 to 95%. For both types of wet scrubbers, operating parameters affecting SO<sub>2</sub> removal efficiency include liquid-to-gas ratio, pH of the scrubbing medium, and the ratio of calcium sorbent to SO<sub>2</sub>. Periodic maintenance is needed because of scaling, erosion, and plugging problems. Recent advancements include the use of additives or design changes to promote SO<sub>2</sub> absorption or to reduce scaling and precipitation problems.

A spray dryer absorber (sometimes referred to as wet-dry or semi-dry scrubbers) operates by the same principle as wet lime scrubbing, except that the flue gas is contacted with a fine mist of lime slurry instead of a bulk liquid (as in wet scrubbing). For the spray dryer absorber process, the combustion gas containing SO<sub>2</sub> is contacted with fine spray droplets of hydrated lime slurry in a spray dryer vessel. This vessel is located downstream of the air heater outlet where the gas temperatures are in the range of 120 to 180 °C (250 to 350 °F). The SO<sub>2</sub> is absorbed in the slurry and reacts with the hydrated lime reagent to form solid calcium sulfite and calcium sulfate as in a wet lime scrubber. The water is evaporated by the hot flue gas and forms dry, solid particles containing the reacted sulfur. These particles are entrained in the flue gas, along with fly ash, and are collected in a PM collection device. Most of the SO<sub>2</sub> removal occurs in the spray dryer vessel itself, although some additional SO<sub>2</sub> capture has also been observed in downstream particulate collection devices, especially fabric filters. This process produces dry reaction waste products for easy disposal.

The primary operating parameters affecting SO<sub>2</sub> removal are the calcium-reagent-to-sulfur stoichiometric ratio and the approach to saturation in the spray dryer. To increase overall sorbent use, the solids collected in the spray dryer and the PM collection device may be recycled. The SO<sub>2</sub> removal efficiencies of existing lime spray dryer systems range from 60-95%.

For the dry injection process, dry powdered lime (or another suitable sorbent such as trona) is directly injected into the ductwork upstream of a PM control device. Some systems use spray

humidification followed by dry injection. This dry process eliminates the slurry production and handling equipment required for wet scrubbers and spray dryers, and produces dry reaction waste products for easier disposal. The SO<sub>2</sub> is adsorbed and reacts with the powdered sorbent. The dry solids are entrained in the combustion gas stream, along with fly ash, and collected by the PM control device. The SO<sub>2</sub> removal efficiencies of existing dry injection systems range from 40 to 60%.

## **FOUR FACTOR ANALYSIS OF POTENTIAL CONTROL SCENARIOS FOR ICI BOILERS**

Each of the control options presented in Table 4.1 is reviewed in this section utilizing a four factor analysis approach for determining reasonable progress as required by Section 169A(g)(1) of the Clean Air Act and Section 51.308(d)(1)(i)(A). The information provided in this section is intended to be used by the States in setting Reasonable Progress Goals (RPGs) for reducing regional haze in Class I areas in MANE-VU Class I areas.

### **Cost of Compliance**

To compare the various control options, information has been compiled on the cost-effectiveness of retrofitting controls. In general, cost-effectiveness increases as boiler size and capacity factor (a measure of boiler utilization) increases.

### **Cost of Switching to Low Sulfur Coal, Distillate Oil, or Natural Gas**

Switching to a low-sulfur coal or blending a lower sulfur coal can impact cost due to the following two main reasons:

1. The cost of low-sulfur coal compared to higher sulfur coal.
2. The cost of boiler or coal handling equipment modifications necessary

The cost of low-sulfur coal compared to higher sulfur coal is not only related to the “dollar per ton” cost of the coal, but the heating value of the coal also impacts the cost analysis.

Table 4.2 reflects the potential sulfur reduction possible by switching fuels:

Table 4.3 shows the average 2004 and 2005 cost data from the Energy Information Administration for various fuels.

Refineries were required to make significant capital investments to meet the LSD and ULSD highway fuel sulfur requirement. To achieve the LSD and ULSD sulfur goals, refineries were required to implement diesel desulfurization technologies. Estimates for the capital costs were developed in 2001 by the Energy Information Administration (EIA) and are based on calendar year 1999. Table 4.4 presents the capital costs for desulfurization technologies presented by the EIA. The EIA developed estimates for new and revamped desulfurization technologies at existing refineries.

**Table 4.2 Potential SO<sub>2</sub> Reductions Through Fuel Switching**

<b>Original Fuel</b>	<b>Sub-bituminous Coal (% Reduction)</b>	<b>Distillate oil (% Reduction)</b>	<b>Natural Gas (% Reduction)</b>
Bituminous Coal	72.9	91.2	99.9
Sub-bituminous coal	-	69.5	99.9
Residual Oil	-	91.5	99.9
Distillate Oil	-	-	99.7

Calculations based on typical fuel sulfur content listed in Department of Energy EIA analysis for 2000. *Energy Policy Act Transportation Rate Study Final Report on Coal Transportation*

In its highway diesel fuel rulemaking, EPA also developed cost estimates for the deployment and implementation of desulfurization technologies at refineries. EPA estimated that it would cost existing refineries an estimated \$50 million per refinery to install desulfurization technologies. No estimates were made for the costs associated with new refineries as none are currently being constructed in the United States. The EPA analysis spread the investment cost over a 2-year period. Consequently, it was estimated that the US refinery-wide investment for calendar year 2004 was \$2.45 billion and \$2.83 billion for calendar year 2005 (EIA 2001) (Converted from 2001 to 2006 dollars using a conversion factor of 1.1383 [www.inflationdata.com](http://www.inflationdata.com)).

Using the most recently available EIA price information for 2006 No. 2 Distillate oil for industrial, commercial, and institutional facilities in the northeast (excluding taxes), a cost per ton of SO<sub>2</sub> removed was calculated to be \$734/ton SO<sub>2</sub> by switching to 500 ppm LSD and \$554/ton SO<sub>2</sub> by switching to ULSD fuel oils. (See the discussion of fuel oil prices in Chapter 7 – Heating Oil.)

Cost of Coal Cleaning

The World Bank, an organization which assists with economic and technological needs in developing countries reports that the cost of physically cleaning coal varies from \$1 to \$10 per ton of coal cleaned, depending on the coal quality, the cleaning process used, and the degree of cleaning desired. In most cases the costs were found to be between \$1 and \$5 per ton of coal cleaned.

Cost of Combustion Control

Dry sorbent injection, (DSI), systems have lower capital and operation costs than post-combustion FGD systems due to: simplicity of design, lower water use requirements, and smaller land use requirements. Table 4.3 presents the estimated costs of adding DSI based SO<sub>2</sub> controls to ICI boilers based on boiler size, fuel type, and capacity factor. Capacity factor is the amount of energy a boiler generates in one year divided by the total amount it could generate if it ran at full capacity.

**Table 4.3 Estimated Dry Sorbent Injection (DSI) Costs For ICI Boilers (2006 dollars)**

Fuel	SO <sub>2</sub> Reduction (%)	Capacity Factor (%)	Cost Effectiveness (\$/Ton of SO <sub>2</sub> )		
			100 MMBTU/hr	250 MMBTU/hr	1,000 MMBTU/hr
2%-sulfur coal	40	14	4,686	3793	2,979
		50	1,312	1062	834
		83	772	624	490
3.43%-sulfur coal	40	14	2,732	2,212	1,737
		50	765	619	486
		83	450	364	286
2%-sulfur coal	85	14	2,205	1,786	1,402
		50	617	500	392
		83	363	294	231
3.43%-sulfur coal	85	14	1,286	1,040	818
		50	360	291	229
		83	212	171	134

Calculations based on information available from EPA Publications, EPA-452/F-03-034, *Air Pollution Control Technology Fact Sheet*, and EPA-600/R-05-034, *Multipollutant Emission Control Technology Options for Coal-fired Power Plants*

(Converted from 2005 to 2006 dollars using a conversion factor of 1.0322 [www.inflationdata.com](http://www.inflationdata.com))

Cost of FGD

Installation of post-combustion SO<sub>2</sub> control in the form of FGD has several impacts on facility operation, maintenance, and waste handling. FGD systems typically require significant area for construction of the absorber towers, sorbent tanks, and waste handling. The facility costs are, therefore, variable and dependent on the availability of space for construction of the FGD system. Solid waste handling is another factor that influences the cost of FGD control systems. Significant waste material may be generated that requires disposal. This cost may be mitigated, however, by utilization of a forced oxidation FGD process that produces commercial quality gypsum, which may be sold as a raw material for other commercial processes.

Table 4.4 presents the total estimated cost effectiveness of adding FGD based SO<sub>2</sub> controls to ICI boilers based on boiler size, fuel type, and capacity factor. There is no indication that these cost data include revenue from gypsum sales. Revenue from gypsum sales would reduce the cost of these controls.

**Table 4.4 Estimated Flue Gas Desulfurization (FGD) Costs For ICI Boilers (2006 dollars)**

Fuel	Technology	SO <sub>2</sub> Reduction (%)	Capacity Factor (%)	Cost Effectiveness (\$/Ton of SO <sub>2</sub> )		
				100 MMBTU/hr	250 MMBTU/hr	1,000 MMBTU/hr
High-sulfur coal <sup>a</sup>	FGD (Dry)	40	14	3,781	2,637	1,817
			50	1,379	1,059	828
			83	1,006	814	676
Lower-sulfur coal <sup>b</sup>	FGD (Dry)	40	14	4,571	3,150	2,119
			50	1,605	1,207	928
			83	1,147	906	744
Coal	FGD (Spray dry)	90	14	4,183	2,786	1,601
			50	1,290	899	567
			83	843	607	407
High-sulfur coal <sup>a</sup>	FGD (Wet)	90	14	3,642	2,890	1,909
			50	1,116	875	601
			83	709	563	398
Lower-sulfur coal <sup>b</sup>	FGD (Wet)	90	14	4,797	3,693	2,426
			50	1,415	1,106	751
			83	892	705	492
Oil <sup>c</sup>	FGD (Wet)	90	14	10,843	8,325	5,424
			50	2,269	1,765	1,184
			83	1,371	1,079	740

a Assumes sulfur content = 3.43% and ash content = 12.71%

b Assumes sulfur content = 2.0% and ash content = 13.2%

c Sulfur content of oil is not specified

Table references:

Source: *Controlling Fine Particulate Matter Under the Clean Air Act: A Menu of Options*, STAPPA-ALAPCO, 2006.

Primary Reference: Khan, S. *Methodology, Assumptions, and References—Preliminary SO<sub>2</sub> Controls Cost Estimates for Industrial Boilers* (EPA-HQ-OAR-2003-0053-166), October-November 2003.

(Converted from 2004 to 2006 dollars using a conversion factor of 1.0672 [www.inflationdata.com](http://www.inflationdata.com))

### Time Necessary for Compliance

Generally, sources are given a 2-4 year phase-in period to comply with new rules. Under the previous Phase I of the NO<sub>x</sub> SIP Call, EPA provided a compliance date of about 3½ years from the SIP submittal date. Most MACT standards allow a 3-year compliance period. Under Phase II

of the NO<sub>x</sub> SIP Call, EPA provided a 2-year period after the SIP submittal date for compliance. States generally provided a 2-year period for compliance with RACT rules. For the purposes of this review, we have assumed that a 2-year period after SIP submittal is adequate for pre-combustion controls (fuel switching or cleaning) and a three year period for the installation of post combustion controls.

For BART control measures, the proposed BART guidelines require States to establish enforceable limits and require compliance with the BART emission limitations no later than 5 years after EPA approves the regional haze SIP.

Refiners in the United States are already producing low sulfur diesel fuel which may be marketed as distillate oil. There is a potential that offshore refiners may not be able to produce enough 15 ppm sulfur for export to the Northeast United States to meet peak demand, but so far this has not occurred.

ICI boilers would not have to retrofit or install expensive control technology to burn ULSD distillate fuel oil, therefore, compliance with the standard is driven by supply and demand of the lower sulfur distillate oils.

For combustion based and post-combustion based engineering and construction leads times will vary between 2 and 5 years depending on the size of the facility and specific control technology selected.

### **Energy and Non-Air Impacts**

Fuel switching and cleaning do not significantly affect the efficiency of the boiler but may add to transportation issues and secondary environmental impacts from waste disposal and material handling operations (e.g. fugitive dust). FGD systems typically operate with high pressure drops across the control equipment, resulting in a significant amount of electricity required to operate blowers and circulation pumps. In addition, some combinations of FGD technology and plant configuration may require flue gas reheating to prevent physical damage to equipment, resulting in higher fuel usage.

The primary environmental impact of FGD systems is the generation of wastewater and sludge from the SO<sub>2</sub> removal process. When the exhaust gas from the boiler enters the FGD the SO<sub>2</sub>, metals, and other solids are removed from the exhaust and collected in the FGD liquid. The liquid slurry collects in the bottom of the FGD in a reaction tank. The slurry is then dewatered and a portion of the contaminant-laden water is removed from the system as wastewater. Waste from the FGD systems will increase sulfate, metals, and solids loading in a facility's wastewater, potentially impacting community wastewater treatment facilities for smaller units that do not have self contained water treatment systems. In some cases FGD operation necessitates installation of a clarifier on site to remove excessive pollutants from wastewater. This places additional burdens on a facility or community wastewater treatment and solid waste management capabilities. These impacts will need to be analyzed on a site-specific basis. If lime or limestone scrubbing is used to produce calcium sulfite sludge, the sludge must be stabilized prior to land filling. If a calcium sulfate sludge is produced, dewatering alone is necessary before land filling,

however, SO<sub>2</sub> removal costs are higher due to increased equipment costs for this type of control system. In some cases calcium sulfate sludge can be sold for use in cement manufacturing.

With wet FGD technologies a significant visible plume is present from the source due to condensation of water vapor as it exits the smoke stack. Although the water eventually evaporates and the plume disappears, community impact may be significant.

Reducing the sulfur contents of distillate fuel oil has a variety of beneficial consequences for ICI boilers. Low sulfur distillate fuel is cleaner burning and emits less particulate matter which reduces the rate of fouling of heating units substantially and permits longer time intervals between cleanings. According to a study conducted by the New York State Energy Research and Development Authority, (NYSERDA), boiler deposits are reduced by a factor of two by lowering the fuel sulfur content from 1,400 ppm to 500 ppm. These reductions in buildup of deposits result in longer service intervals between cleanings. (Batey and McDonald 2005)

#### **Remaining Useful Life of the Source**

Available information for remaining useful life estimates of ICI boilers indicates a wide range of operating time, depending on size of the unit, capacity factor, and level of maintenance performed. Typical life expectancies range from about 10 years up to over 30 years.



## REFERENCES

- Batey, J.E. and R. McDonald, 2005. *Low Sulfur Home Heating Oil Demonstration Project Summary Report*. Project funded by The New York State Energy Research and Development Authority. Contract No. 6204-IABR-BR-00.
- U.S. EPA, 2005, *Multipoint Emission Control Technology Options for Coal-fired Power Plants*, Washington, DC, EPA-600/R-05/034.
- U.S. EPA, 2003, *Air Pollution Control Technology Fact Sheet*, Washington, DC, EPA-425/F-03-034.
- STAPPA ALAPCO, 2006, *Controlling Fine Particulate Matter Under the Clean Air Act: A Menu of Options*.
- The Lake Michigan Air Directors Consortium, *Midwest Regional Planning Organization Boiler Best Available Retrofit Technology Engineering Analysis*, March 30, 2005
- U.S. EPA, 1993, *PM-10 Innovative Strategies: A Sourcebook for PM-10 Control Programs*, Research Triangle Park, NC, EPA-452/R-93-016.
- U.S. Energy Information Administration, October 2000, *Energy Policy Act Transportation Rate Study: Final Report on Coal Transportation*, Publication downloaded from World Wide Web in February, 2007 at [http://www.eia.doe.gov/cneaf/coal/coal\\_trans/epact2000.html](http://www.eia.doe.gov/cneaf/coal/coal_trans/epact2000.html)
- GE Water & Process Technologies. Information accessed on web March 27, 2007: [http://www.zenon.com/applications/FGD\\_wastewater\\_treatment.shtml](http://www.zenon.com/applications/FGD_wastewater_treatment.shtml)
- U.S. Energy Information Administration, 2007. "No. 2 Distillate Prices By Sales Type", Information downloaded from the World Wide Web on March 7, 2007, at [http://tonto.eia.doe.gov/dnav/pet/pet\\_pri\\_dist\\_dcu\\_R1X\\_m.htm](http://tonto.eia.doe.gov/dnav/pet/pet_pri_dist_dcu_R1X_m.htm)
- U.S. Energy Information Administration, 2007. "weekly Inputs, Utilization and Production", Information downloaded from the World Wide Web on March 7, 2007, at [http://tonto.eia.doe.gov/dnav/pet/pet\\_pnp\\_wiup\\_dcu\\_r10\\_w.htm](http://tonto.eia.doe.gov/dnav/pet/pet_pnp_wiup_dcu_r10_w.htm)

This page left blank intentionally.

## CHAPTER 5

### ANALYSIS OF SELECTED INDUSTRIAL, COMMERCIAL, AND INSTITUTIONAL BOILERS

#### SOURCE CATEGORY DESCRIPTION

Modeling of visibility impacts on Class I regions was conducted by the Vermont Department of Environmental Conservation (VTDEC) and MANE-VU to identify the major ICI sources contributing to visibility impairment in the northeast. Table 5.1 lists the ICI sources identified to contribute significant levels of SO<sub>2</sub> to the MANE-VU region. MACTEC was directed by MARAMA and the Reasonable Progress Workgroup to focus on the 17 major sources listed in Table 5.1.

As explained in the previous chapter, there are a wide variety of proven control technologies for reducing SO<sub>2</sub> emissions from ICI boilers and specifically the control method for SO<sub>2</sub> applied to any individual ICI boiler is dependent upon the type of boiler, type of fuel, capacity utilization, and the types and staging of other air pollution control devices. However, cost effective emissions reduction technologies for SO<sub>2</sub> are available and are effective in reducing emissions from the exhaust gas stream of ICI boilers.

#### INFORMATION OBTAINED FROM STATE AGENCIES

For the selected ICI boilers, MACTEC contacted State and or regional regulatory agencies to evaluate the status of each unit and determine if additional pollution controls had been mandated as a part of regulatory actions taken since the data used for the visibility impairment modeling were collected. Table 5.1 presents the information obtained from the States.

**Table 5.1 Point Source Information Collected from the Top 17 Industrial Facilities Responsible for Visibility Impairment in MANE-VU Class I Areas**

Facility Name	State	2002 SO <sub>2</sub> Total (tons)	Primary Emissions Point Description	Point ID (Permit ID No.)	Design Capacity	Existing Control(s)	Proposed/Planned Control(s)	Additional Information
Motiva Enterprises LLC – Delaware City <sup>1</sup>	DE	29,747	Fluid Coking Unit (FCU) and FCU Carbon Monoxide Boiler	002	57,199 barrels per day of total feed	None	Cansolv Regenerative Wet Gas Scrubber and SNCR	Data from Permit APC-82/0829 Amendment 5 SO <sub>2</sub> permit limit is 174 tpy
			Fluid Catalytic Cracking Unit (FCCU) and FCCU Carbon Monoxide Boiler	012	FCCU coke burn rate limit is 56,000 lbs/hr	None	Cansolv Regenerative Wet Gas Scrubber	Data from Permit APC-82/0981 Amendment 6 SO <sub>2</sub> permit limit is 361 tpy

**Table 5.1 Point Source Information Collected from the Top 17 Industrial Facilities Responsible for Visibility Impairment in MANE-VU Class I Areas**

Facility Name	State	2002 SO <sub>2</sub> Total (tons)	Primary Emissions Point Description	Point ID (Permit ID No.)	Design Capacity	Existing Control(s)	Proposed/Planned Control(s)	Additional Information
Kodak Park Division <sup>2,3</sup>	NY	23,508	Building 31 and 321 stationary combustion installations, including package ABD built up boilers used for the generation of process steam and electricity Boilers: 1 – Package boiler, No. 6 2 – Package boiler, No. 6 3 – Package boiler, No. 6 4 – Package boiler, No. 6 13 – Underfed stoker, coal 14 – Underfed stoker, coal 11 – Underfed stoker, coal 12 – Underfed stoker, coal 15 – Wet bottom cyclone, coal/No. 6 16 – Wall-fired, coal/No. 6 41 – Wet bottom cyclone, coal/No. 6 42 – Wet bottom cyclone, coal/No. 6 43 – Wet bottom cyclone, coal/No. 6 44 – Tangential-fired pulverized coal, coal/No. 2	U0015		None	BART analysis - NO <sub>x</sub> & SO <sub>2</sub> controls affordable on Boilers 41, 42, & 43 Wet scrubber (90% reduction) would be ~\$2,150/ton Dry scrubber (40% reduction) would be ~\$1,850/ton	Process K07 (Bldg 31) is No. 6 fuel oil combustion in package boilers Process K09 (Bldg 31) is bituminous coal combustion in built up Boilers 13 and 14 Process K10 (Bldg 31) is No. 6 fuel oil combustion in built up Boilers 15 and 16 Process K11 (Bldg 31) is bituminous coal combustion for built up Boiler 15 Process K12 (Bldg 321) is No. 6 fuel oil combustion for built up Boilers 41, 42 and 43 Process K13 (Bldg 321) is bituminous coal combustion for built up Boilers 41, 42 and 43 Process K14 (Bldg 321) is No. 2 fuel oil combustion with NSPS applicability in Boiler 44 Process K15 (Bldg 321) is bituminous low sulfur coal combustion
				Boilers (EP-031B-1):				
				1	98 MMBTU/hr			
				2	98 MMBTU/hr			
				3	98 MMBTU/hr			
				4	98 MMBTU/hr			
				13	265 MMBTU/hr			
				14	265 MMBTU/hr			
				Boilers (EP-031B-2):				
				11	197 MMBTU/hr			
				12	222 MMBTU/hr			
				15	478 MMBTU/hr			
				16	544 MMBTU/hr			
				Boilers (EP-321B-3):				
				41	500 MMBTU/hr			
				42	500 MMBTU/hr			
				Boilers (EP-321B-4):				
43	640 MMBTU/hr							
44	670 MMBTU/hr							

**Table 5.1 Point Source Information Collected from the Top 17 Industrial Facilities Responsible for Visibility Impairment in MANE-VU Class I Areas**

Facility Name	State	2002 SO <sub>2</sub> Total (tons)	Primary Emissions Point Description	Point ID (Permit ID No.)	Design Capacity	Existing Control(s)	Proposed/Planned Control(s)	Additional Information
MW Custom Papers LLC – Chillicothe Mill <sup>4</sup>	OH	23,216	No.5 Coal Boiler - wet bottom, pulverized coal-fired boiler (C. E. model VU-40), capable of running on #2 fuel oil as backup fuel	B001	380 MMBTU/hr maximum heat input	Cyclone/ multi-clone ESP	None	9.9 lbs of sulfur dioxide per MMBTU actual heat input
			No.7 Coal Boiler - wet bottom, pulverized coal-fired boiler (C. E. model VU-405), capable of running on #2 fuel oil as backup fuel	B002	422 MMBTU/hr maximum heat input	Cyclone/ multi-clone ESP	None	9.9 lbs of sulfur dioxide per MMBTU actual heat input
			No.8 Coal Boiler - wet bottom, pulverized coal-fired boiler (C. E. model VU-40), capable of running on #2 fuel oil as backup fuel.	B003	505 MMBTU/hr maximum heat input	Cyclone/ multi-clone ESP	None	9.9 lbs of sulfur dioxide per MMBTU actual heat input

**Table 5.1 Point Source Information Collected from the Top 17 Industrial Facilities Responsible for Visibility Impairment in MANE-VU Class I Areas**

Facility Name	State	2002 SO <sub>2</sub> Total (tons)	Primary Emissions Point Description	Point ID (Permit ID No.)	Design Capacity	Existing Control(s)	Proposed/Planned Control(s)	Additional Information
Eastman Chemical Company <sup>5,6</sup>	TN	22,882	Two fuel burning installations (B-83-1 & B-253-1) w/a total of 19 coal fired boilers of which 14 units (#18-#24) are located at Powerhouse B-83-1 & 5 units (#25-#29) are located at Powerhouse B-253-1. The primary fuel is coal. In addition, wood, waste solids, waste liquids, & biosludge may be burned in these Powerhouses, while NG & process gas may also be burned in the Powerhouse B-253-1 boilers.	82-0003-01-19 (020101, 021520)	6,625 Million BTU/hr nominal heat input	ESP	Scubbers potentially	The five boilers in Powerhouse B-253-1 are subject to BART. The State does not have confirmation yet, but they believe that the boilers will be controlled by scrubbers of some sort. Units #11-#17, that were located at Powerhouse B-83-1, have been removed
			Coal-Fired Boilers 30 and 31	PES B-325-1 or 82-1010-15 (261501)	Heat input is limited to 780 and 880 MMBTU/hr, respectively, on a 30 calendar day rolling average basis	None	None	
Westvaco Fine Papers <sup>7,8</sup>	MD	19,083	Boiler 24 is a coal fired-cyclone boiler	1	590 MMBTU/hr maximum heat input	SNCR (NO <sub>x</sub> ) ESP (PM)	Baghouse (PM)	Not BART eligible due to age

**Table 5.1 Point Source Information Collected from the Top 17 Industrial Facilities Responsible for Visibility Impairment in MANE-VU Class I Areas**

Facility Name	State	2002 SO <sub>2</sub> Total (tons)	Primary Emissions Point Description	Point ID (Permit ID No.)	Design Capacity	Existing Control(s)	Proposed/Planned Control(s)	Additional Information
			Boiler 25 is a coal fired-tangential boiler	2	785 MMBTU/hr maximum heat input	Low NO <sub>x</sub> burners/overfired air (NO <sub>x</sub> ) ESP (PM)	Scrubber (FGD in design) SNCR (NO <sub>x</sub> ) Baghouse to replace ESP (PM)	BART eligible
PPG Industries Inc. <sup>9</sup>	WV	12,678	Boiler 3 is a coal-fired boiler installed in 1942 and modified in 1981	R011 (002) or S076	243 MMBTU/hr	Fabric filter Low NO <sub>x</sub> burners	None	Not BART eligible
			Boiler 4 is a coal-fired and natural gas-fired boiler installed in 1952	R015 (001) or S076	496 MMBTU/hr	ESP Low NO <sub>x</sub> burners	None	Not BART eligible
			Boiler 5 is a coal-fired boiler installed in 1966	R072 (003) or S482	878 MMBTU/hr	ESP Low NO <sub>x</sub> burners	None	BART eligible, facility to decrease emissions by using low-sulfur coal and taking an emission limit of 1,478.8 lb SO <sub>2</sub> /hr



**Table 5.1 Point Source Information Collected from the Top 17 Industrial Facilities Responsible for Visibility Impairment in MANE-VU Class I Areas**

Facility Name	State	2002 SO <sub>2</sub> Total (tons)	Primary Emissions Point Description	Point ID (Permit ID No.)	Design Capacity	Existing Control(s)	Proposed/Planned Control(s)	Additional Information
Williams Ethanol Services Inc. <sup>10, 11</sup>	IL	12,244	4 boilers Boiler A & B are coal-fired boilers constructed in 1944 Boiler C is a coal/oil supplemental-fired boiler constructed in 1958 Boiler D is a NG/No. 2 oil-fired boiler constructed in 1976	10	Boilers A & B: 242 MMBTU/hr Boiler C: 330 MMBTU/hr Boiler D: 195 MMBTU/hr	Boilers A & B: Multi-cyclone Boiler C: ESP Boiler D: None	None	Not BART eligible. There is also a steep acid preparation system (Unit 2) that converts sulfur into sulfurous acid that will be used for the steeping process. Total sulfur usage for this unit is limited to 961,750 lbs/yr (at least 48% of the sulfur added to steepwater shall be retained in the products shipped from the plant).

**Table 5.1 Point Source Information Collected from the Top 17 Industrial Facilities Responsible for Visibility Impairment in MANE-VU Class I Areas**

Facility Name	State	2002 SO <sub>2</sub> Total (tons)	Primary Emissions Point Description	Point ID (Permit ID No.)	Design Capacity	Existing Control(s)	Proposed/Planned Control(s)	Additional Information
Corn Products International Inc. <sup>10, 11</sup>	IL	9,281	Utilities: Coal fired Boilers #1, #2, & #3 (pre 1972) Natural gas-fired Boilers #4 & #5 (pre 1972) Natural gas-fired Boiler #6 constructed in 1992 2 natural gas-fired turbines constructed in 1995	Group 9	Boilers #1, #2, & #3: 250 MMBTU/hr Boilers #4 & #5: 312.5 MMBTU/hr Boiler #6: 600 MMBTU/hr Turbines: 65 MMBTU/hr	Boilers #1, #2, & #3: ESP Boilers #4 & #5: None Boiler #6: low-NO <sub>x</sub> burner & flue gas recirculation Turbines: None	None	Not BART eligible
Mead Westvaco Packaging Resource Group <sup>12</sup>	VA	8,552	Four (4) boilers #6 – primarily coal-fired #7 – coal/bark/wood-fired #8 - coal/bark/wood-fired #9 – primarily coal-fired	25	550 MMBTU/hr 440 MMBTU/hr 580 MMBTU/hr 807 MMBTU/hr	ESP Scrubbers FGR LNB	None	
PH Glatfelter Co./Spring Grove <sup>13, 14</sup>	PA	7,855	#4 Power Boiler that burns bituminous coal (13 tons/hr), #6 oil (751 gal/hr), & #2 oil (108 gal/hr)	034	363.7 MMBTU/hr	Cyclone dust collector ESP	None	Not BART eligible

**Table 5.1 Point Source Information Collected from the Top 17 Industrial Facilities Responsible for Visibility Impairment in MANE-VU Class I Areas**

Facility Name	State	2002 SO <sub>2</sub> Total (tons)	Primary Emissions Point Description	Point ID (Permit ID No.)	Design Capacity	Existing Control(s)	Proposed/Planned Control(s)	Additional Information
			#5 Power Boiler that burns bituminous coal (10.3 tons/hr), #6 oil (300 gal/hr), "as fired" wood (12.2 tons/hr), & #2 oil (451.2 gal/hr)	035	262.3 MMBTU/hr	Cyclone dust collector ESP	None	BART eligible
Goodyear Tire & Rubber Co. <sup>4</sup>	OH	5,903	"A" Boiler, which is a coal-fired boiler	B101	301 MMBTU/hr	ESP	None	4.64 lbs of sulfur dioxide per MMBTU actual heat input for B101, B102, and B103 exiting through Stack 4
			"B" Boiler, which is a coal-fired boiler	B102	301 MMBTU/hr	ESP	None	4.64 lbs of sulfur dioxide per MMBTU actual heat input for B101, B102, and B103 exiting through Stack 4
			"C" Boiler, which is a coal-fired boiler	B103	174 MMBTU/hr	ESP	None	4.64 lbs of sulfur dioxide per MMBTU actual heat input for B101, B102, and B103 exiting through Stack 4

**Table 5.1 Point Source Information Collected from the Top 17 Industrial Facilities Responsible for Visibility Impairment in MANE-VU Class I Areas**

Facility Name	State	2002 SO <sub>2</sub> Total (tons)	Primary Emissions Point Description	Point ID (Permit ID No.)	Design Capacity	Existing Control(s)	Proposed/Planned Control(s)	Additional Information
Sunoco Inc. (R&M) <sup>15, 16</sup>	PA	3,645	Plt. 10-4 FCC Unit	101	4,792,000 bbl/hr fresh feed	None	SCR and a wet gas scrubber installed in 2010. At the latest, compliance is required by 2013.	SO <sub>2</sub> limit of 9.8 lbs/1000 lbs of coke burn-off in the catalyst regenerator determined daily on a 7-day rolling average basis
Valero Refining Co. – NJ <sup>17, 18</sup>	NJ	3,597	FCCU Regenerator with In-Line Heater	E21 or U1	102 MMBTU/hr	WGS	None	Per Consent Decree, SO <sub>2</sub> concentration emission limits at the point of emission to the atmosphere of no greater than 25 ppmvd, measured as a 365-day rolling average, and 50 ppmvd, measured as a 7-day rolling average, both at 0% O <sub>2</sub> .
Stone Container Corp. (dba Smurfit-Stone Contain) <sup>19</sup>	VA	3,379	#8 Power Boiler that burns bituminous coal	2	1,056 MMBTU/hr	None	Wet gas scrubber (2007)	Consent Decree dated 11/2004 which states that SO <sub>2</sub> emission rate will not exceed 0.26 lb/MMBTU on a 30-day rolling average basis.

**Table 5.1 Point Source Information Collected from the Top 17 Industrial Facilities Responsible for Visibility Impairment in MANE-VU Class I Areas**

Facility Name	State	2002 SO <sub>2</sub> Total (tons)	Primary Emissions Point Description	Point ID (Permit ID No.)	Design Capacity	Existing Control(s)	Proposed/Planned Control(s)	Additional Information
Great Northern Paper Inc. Mill West <sup>20, 21</sup>	ME	1,842	Power Boilers #4 (Riley-Stoker))	004 (WB4)	740 MMBTU/hr	None	None	Unit to be shut down so BART not an issue (only BART eligible source at this facility)
NRG Energy Center Dover LLC <sup>1, 22, 23</sup>	DE	1,836	Riley Stoker Boiler fired on pulverized bituminous coal (primary fuel) and natural gas (for startup/ignition).	C-1 (001)	243 MMBTU/hr	Four (4) DB Riley Low NO <sub>x</sub> burners Cyclonic Combustion Venturi burner assemblies Low excess air ESP w/23,000 ft <sup>2</sup> collecting electrode area	None	Not BART eligible
Sappi-Somerset <sup>20, 21</sup>	ME	1,734	Power Boiler #1 (Babcock & Wilcox)	001 (PB#1)	848 MMBTU/hr (all fuels) & 250 MMBTU/hr (fossil fuels)	None	None	CEMS for SO <sub>2</sub> Facility to reduce SO <sub>2</sub> emissions by 50% by 2013 (BART deadline)

<sup>1</sup> MACTEC Federal Programs, Inc., "Revised Draft Final, Assessing Reasonable Progress for Regional Haze in the Mid-Atlantic North Eastern Class I Areas", March 8, 2007. Comments regarding Motiva Enterprises LLC – Delaware City and NRG Energy Center Dover LLC facilities received from Mr. John Sipple (302-739-9435, [John.Sipple@state.dc.us](mailto:John.Sipple@state.dc.us)) via E-mail on March 13, 2007.

- <sup>2</sup> New York State Department of Environmental Conservation, Division of Air Resources. Personal communications regarding Kodak Park Division facility between Mr. Mike Cronin, P.E. (518-402-8403, [mpcronin@gw.dec.state.ny.us](mailto:mpcronin@gw.dec.state.ny.us)) and Ms. Lori Cress, MACTEC Federal Programs, Inc., on February 1 and 9, 2007.
- <sup>3</sup> New York State Department of Environmental Conservation, Division of Air Resources. Personal communications regarding Kodak Park Division facility from Mr. Mike Cronin, P.E. (518-402-8403, [mpcronin@gw.dec.state.ny.us](mailto:mpcronin@gw.dec.state.ny.us)) via E-mail on February 12, 2007.
- <sup>4</sup> Ohio Environmental Protection Agency, Division of Air Pollution Control. Personal communication regarding MW Custom Papers LLC – Chillicothe Mill and Goodyear Tire and Rubber Company facilities from Mr. William Spires (614-644-3618, [bill.spires@epa.state.oh.us](mailto:bill.spires@epa.state.oh.us)) via E-mails on February 20, 2007.
- <sup>5</sup> Tennessee Department of Environment and Conservation, Division of Air Pollution Control. Personal communication regarding Eastman Chemical Company facility from Ms. Julie Aslinger (615-532-0587, [Julie.Aslinger@state.tn.us](mailto:Julie.Aslinger@state.tn.us)) via E-mail on March 1, 2007.
- <sup>6</sup> MACTEC Federal Programs, Inc., “Revised Draft Final, Assessing Reasonable Progress for Regional Haze in the Mid-Atlantic North Eastern Class I Areas”, March 8, 2007. Comments regarding Eastman Chemical Company facility received from Ms. Julie Aslinger (615-532-0587, [Julie.Aslinger@state.tn.us](mailto:Julie.Aslinger@state.tn.us)) via E-mail on March 30, 2007.
- <sup>7</sup> Maryland Department of the Environment. Personal communication regarding Westvaco Fine Papers facility between Mr. Andy Heltibridle (410-537-4218, [aheltibridle@mde.state.md.us](mailto:aheltibridle@mde.state.md.us)) and Ms. Lori Cress, MACTEC Federal Programs, Inc. on January 31, 2007.
- <sup>8</sup> Maryland Department of the Environment. Personal communication regarding Westvaco Fine Papers facility from Mr. Andy Heltibridle (410-537-4218, [aheltibridle@mdc.state.md.us](mailto:aheltibridle@mdc.state.md.us)) via E-mail on January 31, 2007.
- <sup>9</sup> West Virginia Division of Air Quality. Personal communications regarding PPG, Industries, Inc. facility between Ms. Laura Crowder (304-926-0499 Ext. 1247, [LCROWDER@wvdep.org](mailto:LCROWDER@wvdep.org)) and Mr. Steve Pursley (304-926-0499 Ext. 1218) and Ms. Lori Cress, MACTEC Federal Programs, Inc., on March 14, 2007.
- <sup>10</sup> Virginia Department of Environmental Quality, Division of Air Quality. Personal communication regarding Mead Westvaco Packaging Resource Group facility between Ms. Doris McLeod (504-698-4197, [damcleod@deq.virginia.gov](mailto:damcleod@deq.virginia.gov)) and Ms. Lori Cress, MACTEC Federal Programs, Inc., on February 20, 2007.
- <sup>11</sup> Pennsylvania Department of Environmental Protection, Bureau of Air Quality. Personal communication regarding PH Glatfelter Company/Spring Grove facility between Ms. Nancy Herb (717-783-9269, [nherb@state.pa.us](mailto:nherb@state.pa.us)) and Ms. Lori Cress, MACTEC Federal Programs, Inc. on January 31, 2007.
- <sup>12</sup> Pennsylvania Department of Environmental Protection, Bureau of Air Quality. Personal communications regarding PH Glatfelter Company/Spring Grove facility from Ms. Nancy Herb (717-783-9269, [nherb@state.pa.us](mailto:nherb@state.pa.us)) via E-mail on January 31 and February 7, 2007.
- <sup>13</sup> Illinois Environmental Protection Agency, Bureau of Air. Personal communication regarding Williams Ethanol Services Incorporated and Corn Products International Incorporated facilities between Mr. Rob Kaleel (217-524-4387, [Rob.Kaleel@illinois.gov](mailto:Rob.Kaleel@illinois.gov)) and Ms. Lori Cress, MACTEC Federal Programs, Inc. on February 2, 2007.
- <sup>14</sup> Illinois Environmental Protection Agency, Bureau of Air. Personal communication regarding Williams Ethanol Services Incorporated and Corn Products International Incorporated facilities from Mr. Rob Kaleel (217-524-4387, [Rob.Kaleel@illinois.gov](mailto:Rob.Kaleel@illinois.gov)) via E-mail on February 2, 2007.
- <sup>15</sup> Pennsylvania Department of Environmental Protection, Bureau of Air Quality. Personal communications regarding Sunoco Inc. (R&M) facility between Ms. Nancy Herb (717-783-9269, [nherb@state.pa.us](mailto:nherb@state.pa.us)) and Ms. Lori Cress, MACTEC Federal Programs, Inc. on January 31, 2007.
- <sup>16</sup> Pennsylvania Department of Environmental Protection, Bureau of Air Quality. Personal communications regarding Sunoco Inc. (R&M) facility from Ms. Nancy Herb (717-783-9269, [nherb@state.pa.us](mailto:nherb@state.pa.us)) via E-mail on February 22, 2007.
- <sup>17</sup> New Jersey Department of Environmental Protection, Division of Air Quality. Personal communications regarding Valero Refining Company facility between Mr. Ray Papalski (609-633-7225, [Ray.Papalski@dep.state.nj.us](mailto:Ray.Papalski@dep.state.nj.us)) and Ms. Lori Cress, MACTEC Federal Programs, Inc. on January 31 and February 2, 2007.
- <sup>18</sup> New Jersey Department of Environmental Protection, Division of Air Quality. Personal communication regarding Valero Refining Company facility from Mr. Ray Papalski (609-633-7225, [Ray.Papalski@dep.state.nj.us](mailto:Ray.Papalski@dep.state.nj.us)) via E-mail on February 21, 2007.
- <sup>19</sup> Virginia Department of Environmental Quality, Division of Air Quality. Personal communication regarding Stone Container Corporation facility from Ms. Doris McLeod (504-698-4197, [damcleod@deq.virginia.gov](mailto:damcleod@deq.virginia.gov)) via E-mail on February 9, 2007.
- <sup>20</sup> Maine Department of Environmental Protection Agency, Bureau of Air Quality. Personal communications regarding Great Northern Paper Incorporated Mill West and Sappi - Somerset facilities between Ms Lynn Ross (207-287-8106, [Lynn.Ross@maine.gov](mailto:Lynn.Ross@maine.gov)) and Mr. Marc Cone (207-287-2437) and Ms. Lori Cress, MACTEC Federal Programs, Inc. on February 2, 2007.
- <sup>21</sup> Maine Department of Environmental Protection Agency, Bureau of Air Quality. Personal communication regarding Great Northern Paper Incorporated Mill West and Sappi - Somerset facilities between Ms Lynn Ross (207-287-8106, [Lynn.Ross@maine.gov](mailto:Lynn.Ross@maine.gov)) via E-mail on February 2, 2007.

- <sup>22</sup> Delaware Department of Natural Resources and Environmental Control, Division of Air and Waste Management. Personal communications regarding NRG Energy Center Dover LLC facility between Ms. Tammy Henry (302-323-4542, [Tammy.Henry@state.de.us](mailto:Tammy.Henry@state.de.us)) and Ms. Lori Cress, MACTEC Federal Programs, Inc. on March 5, 2007.
- <sup>23</sup> Delaware Department of Natural Resources and Environmental Control, Division of Air and Waste Management. Personal communications regarding NRG Energy Center Dover LLC facility from Ms. Tammy Henry (302-323-4542, [Tammy.Henry@state.de.us](mailto:Tammy.Henry@state.de.us)) via E-mail on March 5, 2007.

This page left blank intentionally.



## CHAPTER 6

### SOURCE CATEGORY ANALYSIS: KILNS

#### SOURCE CATEGORY DESCRIPTION

Portland cement is a main ingredient for concrete and other common building materials. Portland cement is mainly composed of clinker, a material formed by heating limestone and other ingredients to temperatures over 1,400°C (2,650°F). High combustion temperatures require large amounts of fuel and can result in significant emissions of SO<sub>2</sub> and NO<sub>x</sub>. Crushing of ingredients and finished clinker can release dust and particles. Ammonia is sometimes produced during the heating of limestone.

Figure 6.1 shows a process flow diagram of a Portland cement facility. The process flow diagram (taken from AP-42) shows both wet and dry Portland cement processes.

Figure 6.1 Portland Cement Process Flow Diagram

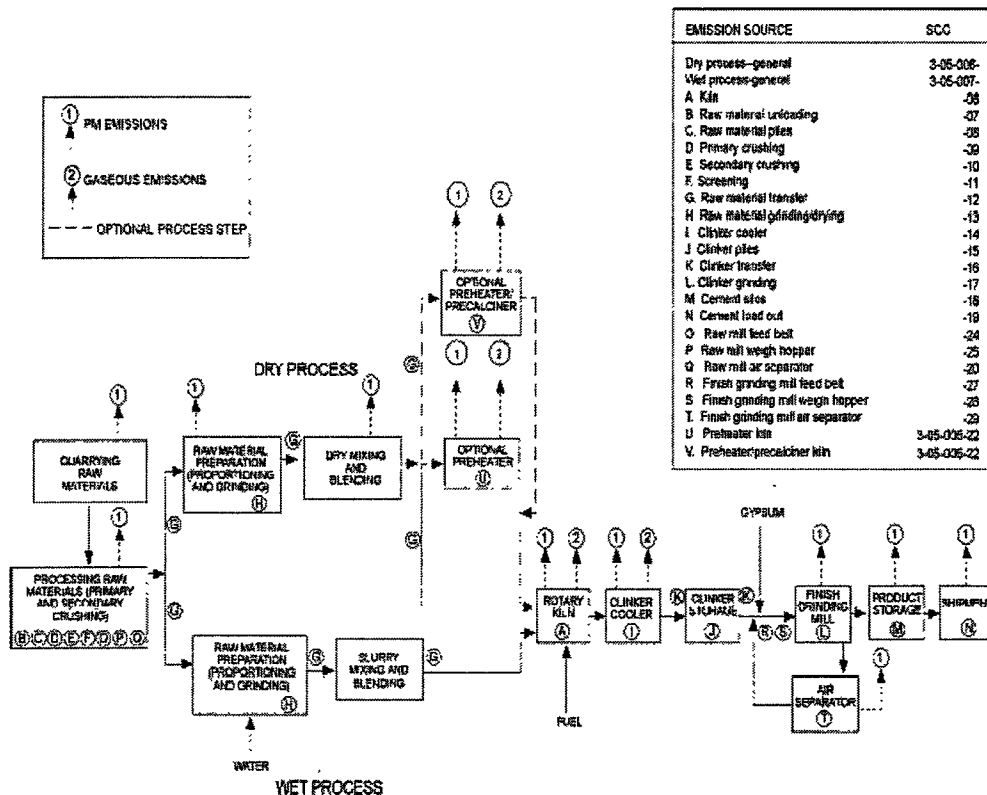

EPA, January, 1995. AP42 Section 11.6 – “Portland Cement Manufacturing”.

Figure 6.1 shows that the Portland cement process can generally be broken down into the following steps: raw materials handling, raw material preparation, dry mixing, optional

preheating and/or precalcining, kiln treatment (pyroprocessing step), clinker handling and storage, and finishing operations (finishing, storage and shipment). The pyroprocessing step transforms the raw mix into clinkers, which are gray, glass-hard, spherically shaped nodules that range from 0.125 to 2.0 inches in diameter.

The pyroprocessing step is the predominant source of gaseous pollutant emissions. In general, there are five different processes used in the Portland cement industry to accomplish the pyroprocessing step: the wet process, the dry process (long dry process), the semidry process, the dry process with a preheater, and the dry process with a preheater/precalciner.

Each of the pyroprocessing types vary with respect to equipment design, method of operation, and fuel consumption. Generally, fuel consumption decreases in the order of the processes listed due to the heat required to evaporate water present in the raw material slurry (e.g., wet processes use the most fuel).

In the long dry process, all of the pyroprocessing activity occurs in the rotary kiln. Dry process pyroprocessing systems have been improved in thermal efficiency and productive capacity through the addition of one or more cyclone-type preheater vessels in the gas stream exiting the rotary kiln. This system is called the preheater process. The vessels are arranged vertically, in series, and are supported by a structure known as the preheater tower. Hot exhaust gases from the rotary kiln pass countercurrently through the downward-moving raw materials in the preheater vessels. Compared to the simple rotary kiln (long dry process), the heat transfer rate is significantly increased, the degree of heat utilization is greater, and the process time is markedly reduced by the intimate contact of the solid particles with the hot gases. The improved heat transfer allows the length of the rotary kiln to be reduced. An added benefit of the preheater operation is that hot gases from the preheater tower are used to help dry raw materials in the raw mill. Because the catch from the mechanical collectors, fabric filters, and/or electrostatic precipitators (ESP) that follow the raw mill is returned to the process, these devices can also be considered to be production machines as well as pollution control devices.

Additional thermal efficiencies and productivity gains have been achieved by diverting some of the fuel to a calciner vessel at the base of the preheater tower. This system is called the preheater/precalciner process.

Regardless of the type of pyroprocess used, the last component of the pyroprocessing system is the clinker cooler. The clinker cooler serves two main purposes. First, this portion of the process:

- recoups up to 30% of the heat input to the kiln system;
- locks in desirable product qualities by freezing mineralogy; and
- makes it possible to handle the cooled clinker with conventional conveying equipment.

The more common types of clinker coolers are reciprocating grate, planetary, and rotary. In these coolers, the clinker is cooled from about 1,100°C to 90°C (2000°F to 200°F) by ambient air that passes through the clinker and into the rotary kiln for use as combustion air. However, in the reciprocating grate cooler, lower clinker discharge temperatures are achieved by passing an

additional quantity of air through the clinker. Because this additional air cannot be used in the kiln for efficient combustion, it is vented to the atmosphere, used for drying coal or raw materials, or used as a combustion air source for the precalciner.

The second portion of the clinker process, a series of blending and grinding operations, completes the transformation of clinker into finished cement. Up to 5% gypsum or natural anhydrite is added to the clinker during grinding to control the cement setting time, and other specialty chemicals are added as needed to impart specific product properties. This finish milling is accomplished almost exclusively in ball or tube mills. Typically, finishing is conducted in a closed-circuit system, with product sizing by air separation.

Coal is the fuel of choice in cement kilns, primarily because of its low cost, but also because the coal ash contributes to the product. The current fuel usage in cement kilns is about 82% coal; 4% natural gas; and 14% other fuels, mainly combustible waste (industrial waste, tires, sewage sludge, etc.). In addition to conventional fuels, many Portland cement facilities are employing the use of petroleum derived coke (petcoke) blended with coal to fire kilns.

Lime kilns are similar to cement kilns. The kiln is the heart of the lime manufacturing plant, where various fossil fuels (such as coal, petroleum coke, natural gas, and fuel oil) are combusted to produce the heat needed for calcination. There are five different types of kilns used in lime manufacturing: rotary, vertical, double-shaft vertical, rotary hearth, and fluidized bed. The most popular is the rotary kiln, however the double-shaft vertical kiln is an emerging new kiln technology gaining in acceptance primarily due to its energy efficiency. Similar to cement plants, rotary kilns at lime manufacturing plants may also have preheaters to improve energy efficiency. Additionally, energy efficiency is improved by routing exhaust from the lime cooler to the kiln. SO<sub>2</sub> emissions from lime predominately originate from compounds in the limestone feed material and fuels and are formed from the combustion of fuels and the heating of feed material in the kiln.

All types of kilns at lime manufacturing plants use external equipment to cool the lime product, except vertical (including double-shaft) kilns, where the cooling zone is part of the kiln. Ambient air is most often used to cool the lime (although a few use water as the heat transfer medium), and typically all of the heated air stream exiting the cooler goes to the kiln to be used as combustion air for the kiln. The exception to this is the grate cooler, where more airflow is generated than is needed for kiln combustion, and consequently a portion (about 40%) of the grate cooler exhaust is vented to the atmosphere. EPA has estimated that there are about five to ten kilns in the United States that use grate coolers. The emissions from grate coolers include lime dust (PM) and trace metallic HAPs found in the lime dust, but not typically SO<sub>2</sub>.

For cement and lime kilns, add-on control technology options identified for SO<sub>2</sub> include advanced flue gas desulfurization (AFGD), dry FGD, and wet FGD.

## **EVALUATION OF SO<sub>2</sub> EMISSION CONTROL OPTIONS**

Sulfur dioxide may be generated both from the sulfur compounds in the raw materials and from sulfur in the fuel. The sulfur content of both raw materials and fuels varies from plant to plant and with geographic location. However, the alkaline nature of the cement provides for direct

absorption of SO<sub>2</sub> into the product, thereby reducing the quantity of SO<sub>2</sub> emissions in the exhaust stream. Depending on the process and the source of the sulfur, SO<sub>2</sub> absorption ranges from about 70% to more than 95%.

In contrast to electric utility and industrial boilers, SO<sub>2</sub> emissions from rotary cement kilns are not strongly dependent on fuel sulfur content. Instead, SO<sub>2</sub> emissions are more closely related to the amount of sulfide (e.g. pyrite) in kiln feedstocks and to the molar ratio of total sulfur to total alkali input to the system. In cement kilns SO<sub>2</sub> emissions generally depend on:

- Inherent SO<sub>2</sub> removal efficiency of kiln system during processing,
- Form of sulfur (e.g. pyritic) and sulfur concentrations in raw material,
- Molecular ratio between sulfur and alkalis,
- Prevailing conditions (oxidizing or reducing) and their location within the kiln, and
- Temperature profile in the kiln system.

SO<sub>2</sub> emission reductions may also result from attempts to reduce other pollutants (primarily NO<sub>x</sub>), typically due to changes in the flame characteristics of combustion. For example, staged combustion with mid-kiln injection of a low-sulfur fuel may be considered for reducing SO<sub>2</sub>. Similarly, including high pressure air injection at a mid-kiln firing site can limit oxygen in the kiln and suppress SO<sub>2</sub> formation (Hansen, 2002). Since these techniques are primarily used to reduce NO<sub>x</sub> and because their efficiencies are typically more limited than other techniques they are not considered in additional detail here.

Other more specific SO<sub>2</sub> control technologies applicable to cement kilns are listed below. A summary of controls evaluated for this work is provided in Table 6.1. Details of each of the control technologies follow Table 6.1. Additional information on this source category and associated controls can be found in the 2005 NESCAUM document titled: *Assessment of Control Technology Options for BART-Eligible Sources*.

**Table 6.1 SO<sub>2</sub> Control Technologies for Cement Kilns**

Technology	Description	Applicability	Performance
Fuel Switching	Limiting the sulfur content of both raw materials and fuels can reduce releases of SO <sub>2</sub> . Availability of these materials is highly site-specific.	All Kilns	Depends on availability of low-sulfur raw materials
Dry Flue Gas Desulfurization - Spray Dryer Absorption (FGD)	Addition of absorbents such as slaked lime (Ca(OH) <sub>2</sub> ), quicklime (CaO) or activated fly ash with high CaO content to the exhaust gas of the kiln can absorb some of the SO <sub>2</sub> .	All Kilns	60-80% reduction
Wet Flue Gas Desulfurization (FGD)	SO <sub>2</sub> is absorbed by a liquid/slurry sprayed in a spray tower or is bubbled through the liquid/slurry. Wet scrubbers also significantly reduce the HCl, residual dust, metal and NH <sub>3</sub> emissions.	All Kilns	90-99.9% reduction
Advanced Flue Gas Desulfurization (FGD)	DOE demonstrated a retrofit Passamaquoddy Technology Recovery Scrubber™ using cement kiln dust (CKD), an alkaline-rich (potassium) waste, to react with the acidic flue gas.	All Kilns	95-99.5% reduction

Table References:

1. *Assessment of Control Technology Options for BART-Eligible Sources*, NESCAUM, March 2005.
2. Miller, F.M. et. al. *Formation and Techniques of Control of Sulfur Dioxide and Other Sulfur Compounds in Portland Cement Kiln Systems*. Portland Cement Association R&D Serial No. 2460, 2001.

**Fuel Switching**

As with any fuel-fired SO<sub>2</sub> emission source, reduction of sulfur levels in the fuel itself typically results in lowered emissions. However, this technique is less effective in cement-making systems, where SO<sub>2</sub> emissions are not strongly dependent on fuel sulfur content. Depending upon the level of sulfur in a plant's limestone, and more specifically the pyrite content, compared to the sulfur content of its heating fuel, fuel switching may not be sufficient to reduce SO<sub>2</sub> emissions (Tanna and Schipholt, 2004). However, when fuel sulfur levels are high, fuel switching may have a significant benefit in SO<sub>2</sub> levels.

**Flue Gas Desulfurization (FGD)**

Both wet and dry flue gas desulfurization (FGD) systems have been used effectively to control SO<sub>2</sub> emissions from cement kilns. FGD systems at cement facilities typically are, 1) dry flue gas desulfurization (spray dryer absorption) 2) wet flue gas desulfurization, and 3) advanced flue gas desulfurization (AFGD). A brief description of each of these technologies is provided below.

### Dry Flue Gas Desulfurization (Spray Dryer Absorption)

Spray dryer absorption (SDA) systems spray lime slurry into an absorption tower where SO<sub>2</sub> is absorbed by the slurry, forming a mixture of calcium sulfite and calcium sulfate. The liquid-to-gas ratio is such that the water evaporates before the droplets reach the bottom of the tower. The dry solids are carried out with the gas and collected with a fabric filter or ESP. When used to specifically control SO<sub>2</sub>, the term dry flue-gas desulfurization (dry FGD) may also be used. As with other types of dry scrubbing systems (such as lime/limestone injection) exhaust gases that exit at or near the adiabatic saturation temperatures can create problems with this control technology by causing the baghouse filter cake to become saturated with moisture and plug both the filters and the dust removal system. In addition, the lime slurry would not dry properly and would plug up the dust collection system. However there is some argument in the control community that indicates that some of the SO<sub>2</sub> removal actually occurs on the filter cake. Therefore, dry FGD (spray dryer absorption) may not be technically feasible if exit gas temperatures are not substantially above the adiabatic saturation temperatures. For Portland cement facilities, these temperatures are likely to be above the adiabatic saturation temperatures.

Most of the spray dryer type SO<sub>2</sub> control technologies in the cement industry are applied to preheater or preheater/precalciner kilns. Exhaust gases from long dry kilns are cooled by either spray water introduced into the feed end of the kiln or by dilution air-cooling after the gases leave the kiln. Adding a conditioning tower to replace wet suppression or dilution air enables the alkaline slurry system to be used to reduce SO<sub>2</sub> emissions (the equivalent of a spray dryer). The use of an alkaline slurry spray dryer type scrubber should be applied to long wet kilns with care because the addition of the lime slurry may drop the exhaust gases temperature below the acid adiabatic saturation temperatures, creating significant plugging and corrosion problems in the downstream particulate control device, duct work, and induced draft fan.

### Wet Flue Gas Desulfurization (FGD)

Wet scrubbing processes used to control SO<sub>2</sub> and particulate emissions are generally termed flue-gas desulfurization (FGD). FGD utilizes gas absorption technology, the selective transfer of materials from a gas to a contacting liquid, to remove SO<sub>2</sub> in the waste gas. Caustic, crushed limestone, or lime are used as scrubbing agents. Our screening evaluation assumes that lime is the scrubbing agent.

Caustic scrubbing produces a liquid waste, and minimal equipment is needed. When lime or limestone is used as the reagent for SO<sub>2</sub> removal, additional equipment is needed for preparing the lime/limestone slurry and collecting and concentrating the resultant sludge. Calcium sulfite sludge is watery and is typically stabilized with fly ash for land filling. Calcium sulfate sludge is stable and easy to dewater. To produce calcium sulfate, an air injection blower is needed to supply the oxygen for the second reaction to occur. The normal SO<sub>2</sub> control efficiency range for SO<sub>2</sub> scrubbers is 80-90% for low efficiency scrubbers and 90-99.9% for high efficiency scrubbers.

While wet scrubbers have been used successfully in the utility industry, they require more care when used for a Portland cement facility. Calcium sulfate scaling and cementitious buildup when a wet scrubber is used for acid gas control (applied to the exhaust gas from a cement kiln)

can be avoided if these systems are installed downstream of a high efficiency particulate control device (e.g., fabric filter). Failure of the particulate control device can pose difficult problems for a downstream wet scrubber.

### Advanced Flue Gas Desulfurization (FGD)

The AFGD process accomplishes SO<sub>2</sub> removal in a single absorber which performs three functions: prequenching the flue gas, absorbing SO<sub>2</sub>, and oxidizing the resulting calcium sulfite to wallboard-grade gypsum. Figure 6.2 shows the process flow for an AFGD system.

Incoming flue gas is cooled and humidified with process wet suppression before passing to the absorber. In the absorber, two tiers of fountain-like sprays distribute reagent slurry over polymer grid packing that provides a large surface area for gas/liquid contact. The gas then enters a large gas/liquid disengagement zone above the slurry reservoir in the bottom of the absorber and exits through a horizontal mist eliminator.

Figure 6.2 Advanced Flue Gas Desulfurization Process Flow

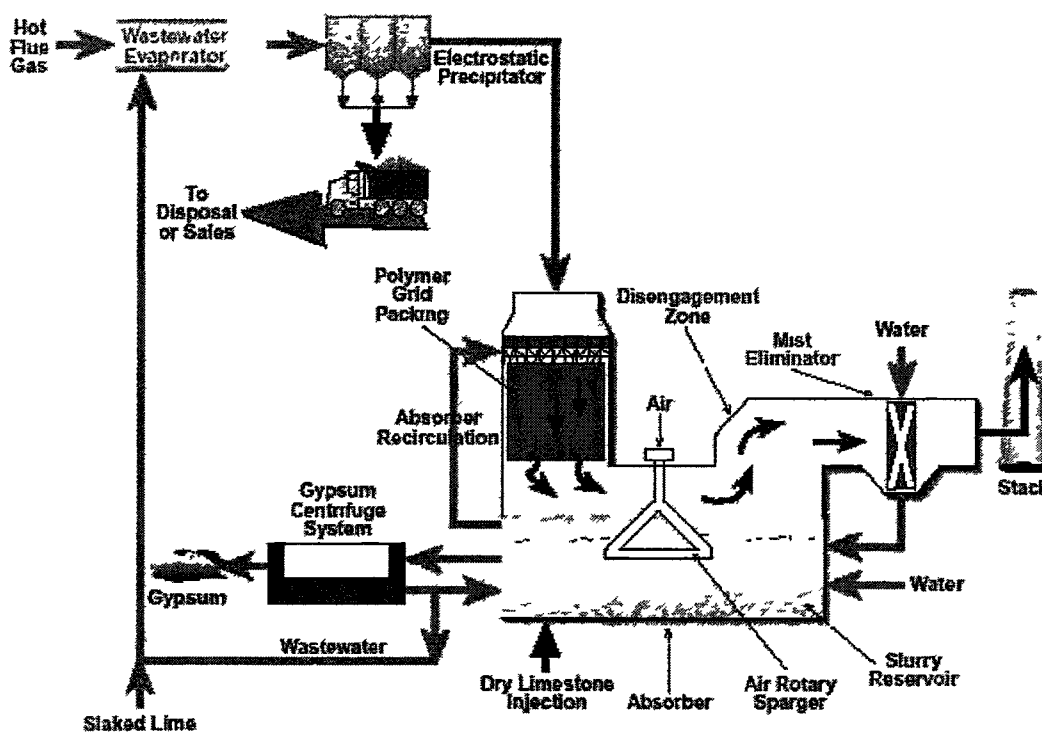

As the flue gas contacts the slurry, the sulfur dioxide is absorbed, neutralized, and partially oxidized to calcium sulfite and calcium sulfate. The overall reactions are shown in the following equations:



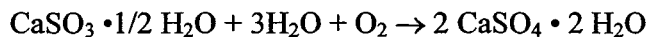

After contacting the flue gas, slurry falls into the slurry reservoir where any unreacted acids are neutralized by limestone injected in dry powder form into the reservoir. The primary reaction product, calcium sulfite, is oxidized to gypsum by the air rotary spargers, which both mix the slurry in the reservoir and inject air into it. Fixed air spargers assist in completing the oxidation. Slurry from the reservoir is circulated to the absorber grid.

A slurry stream is drawn from the tank, dewatered, and washed to remove chlorides and produce wallboard quality gypsum. The resultant gypsum cake contains less than 10% water and 20 ppm chlorides. The clarified liquid is returned to the reservoir, with a slipstream being withdrawn and sent to the wastewater evaporation system for injection into the hot flue gas ahead of the electrostatic precipitator. Water evaporates and dissolved solids are collected along with the flyash for disposal or sale.

The production of gypsum may actually be beneficial for Portland cement as gypsum is added to Portland cement in the final grinding process to regulate the setting time of the concrete. However, to date there are no known installations of AFGD at Portland cement facilities.

### **Inherent Removal**

Removal of SO<sub>2</sub> in the cement manufacturing process is inherent to that process. The raw materials used in the process, primarily limestone, are preheated in the cement-making process either in the preheater tower or in the rotary kiln. In either case, the limestone comes in contact with hot combustion exhaust gases generating a free lime, which then reacts with SO<sub>2</sub> in the gas stream, providing in-process removal of sulfur in the kiln system. Removal efficiencies in rotary kiln systems range between 38% and 99% of sulfur input, and 50% to 70% of the remaining SO<sub>2</sub> is removed from exhaust gases when passing through an in-line raw mill system (Miller et al., 2001). The overall effectiveness and costs associated with this method are highly variable and are related primarily to the type of kiln operation and the ability of the facility to change raw material feeds. These costs can be difficult to quantify.

### **Process Alterations**

The following methods to remove and prevent formation of SO<sub>2</sub> by modifying or controlling conditions in the system are available due to the nature of the Portland cement manufacturing process:

- Change in the oxygen concentration in the flame/exhaust gas area. The concentrations of oxygen and (more importantly) carbon monoxide strongly influence the stability of alkali and calcium sulfates in the burning zone. By ensuring that sufficient oxygen is present to stabilize these compounds, SO<sub>2</sub> emissions can be controlled. Control of burning-zone O<sub>2</sub> and CO concentrations is a widely used industrial practice, and a control technique applicable to all rotary cement kilns. The downside of this technique is the more favorable conditions created for generation of NO<sub>x</sub> in the rotary kiln.



- Burning-zone flame shape can be modified to ensure that reducing conditions in the flame are minimized. Flame impingement in the hot zone has a major effect on SO<sub>2</sub> emissions from the kiln, even if total oxygen is sufficient to fully combust all fuel. Avoiding flame impingement in the burning zone minimizes SO<sub>2</sub> formation. Avoiding flame impingement on the clinker, a technique applicable to all rotary kilns producing cement clinker, requires proper solid fuel preparation and proper flame shaping and control.
- Changes in raw materials to alter the alkali/sulfur molar ratio can also be used to control SO<sub>2</sub> emissions. SO<sub>2</sub> concentrations in kiln exit gases vary with the molar ratio of alkali to sulfur. When there are sufficient alkalis in excess of sulfur, SO<sub>2</sub> emissions are typically low, due to more sulfur being retained as alkali sulfates in the clinker. Cement plants may also change their raw materials to reduce SO<sub>2</sub> emissions. Typically this is accomplished by substituting a raw material containing pyritic sulfur or organic sulfur with one containing lesser amounts of these compounds, leading to reduced SO<sub>2</sub> emissions. Replacement of raw materials, however, is often constrained by economic considerations, while alkali input increase may also be limited by cement product quality specifications on total alkali in cement.
- Alterations to system can influence SO<sub>2</sub> emissions. It has been found that an improved distribution of kiln feed may equalize temperatures in bottom stage cyclones and reduce SO<sub>2</sub> emission by as much as 20% (Miller, 2001).

As with inherent removal, the overall effectiveness and costs associated with this method are highly variable and are related primarily to the type of kiln operation and the ability of the facility to change raw material feeds. These costs can be difficult to quantify.

## **FOUR FACTOR ANALYSIS OF POTENTIAL CONTROL SCENARIOS FOR KILNS**

### **Cost of Compliance**

To compare the various control options, information has been compiled on the cost-effectiveness of retrofitting controls. In general, cost-effectiveness increases with the amount of cement produced by the facility.

In a study performed for LADCO for a BART analysis, MACTEC developed control costs for SO<sub>2</sub> for a "model" cement plant for SO<sub>2</sub>. For the wet scrubber, the control cost estimates were prepared using lime as the base in the scrubbing liquor. Caustic (NaOH) and limestone are potential alternatives for a scrubber and could change the costs slightly. While lime and limestone require additional equipment for slurry preparation and for solids separation from the sludge generated in the scrubber, lime scrubbers are the most commonly used since lime is plentiful and relatively cheap. Materials of construction must also be made suitable for caustic, lime, or limestone if existing equipment is modified for wet scrubbing of SO<sub>2</sub>.

AFGD systems require additional capital costs for the spargers and blowers necessary to oxidize the waste product to gypsum and for equipment to dewater the product (e.g., centrifuge). However if the commercial grade gypsum can be sold or used by the cement facility, some of these costs can be offset.

Dry FGD costs were calculated based on the low and high control efficiencies typical for these systems. For dry scrubbers, the flue gas must be cooled to a temperature 10 to 20 degrees above adiabatic saturation. This is typically accomplished using a heat recovery boiler, an evaporative cooler or a heat exchanger. In addition, if the facility does not have one, a particulate removal device is required for removal of the dry materials used to absorb SO<sub>2</sub>.

For all scrubbers, costs for an additional or upgraded induced air draft fan to make up for pressure drops within the system may be required. In addition, for wet systems, flue gas reheating may be required, thus a reheater may be necessary.

Tables 6.2 – 6.4 present estimated SO<sub>2</sub> control costs for AFGD, Wet FGD, and Dry FGD applied to dry kilns and preheater kilns. The range of costs for these systems vary depending on the size of the kiln and control efficiency, so costs are presented for three size ranges of kilns. Although the capital and annual operating costs of these three types of control vary widely depending on kiln size and control efficiency, the ultimate cost in terms of \$/ton of SO<sub>2</sub> reduction are estimated to be from \$2,000 - \$7,000 for dry kilns and \$9,000 to \$73,000 for preheater kilns.

**Table 6.2 SO<sub>2</sub> Control Costs for AFGD Applied to Dry Kilns and Preheater Kilns  
 (2006 dollars)**

Unit Relative Size	Dry Kiln			Preheater Kiln		
	Capital Costs (10 <sup>6</sup> \$)	Annual Operating Costs (10 <sup>6</sup> \$)	SO <sub>2</sub> Cost Effectiveness (\$/ton SO <sub>2</sub> reduction)	Capital Costs (10 <sup>6</sup> \$)	Annual Operating Costs (10 <sup>6</sup> \$)	SO <sub>2</sub> Cost Effectiveness (\$/ton SO <sub>2</sub> reduction)
Small	\$7.03 – \$22.9	\$3 - \$6	\$2,000 - \$4,000	\$4.5 - \$14.5	\$1.2 – \$11.8	\$13,600- \$38,000
Medium	\$14.1 - \$45.9	\$6.1 - \$11.9		\$8.9 - \$29.0		
Large	\$28.1 - \$91.6	\$12.1 – \$23.7		\$17.8 - \$58.0		

**Table 6.3 SO<sub>2</sub> Control Costs for Wet FGD Applied to Dry Kilns and Preheater Kilns  
 (2006 dollars)**

Unit Relative Size	Dry Kiln			Preheater Kiln		
	Capital Costs (10 <sup>6</sup> \$)	Annual Operating Costs (10 <sup>6</sup> \$)	SO <sub>2</sub> Cost Effectiveness (\$/ton SO <sub>2</sub> reduction)	Capital Costs (10 <sup>6</sup> \$)	Annual Operating Costs (10 <sup>6</sup> \$)	SO <sub>2</sub> Cost Effectiveness (\$/ton SO <sub>2</sub> reduction)
Small	\$2.43 – \$36.5	\$3 - \$9	\$2,000 - \$6,200	\$1.5 - \$23.1	\$0.9 – \$18.9	\$9,700- \$64,600
Medium	\$4.9 - \$73.0	\$6.0 - \$18.4		\$3.1 - \$46.3		
Large	\$9.5 - \$142.5	\$11.9 – \$36.8		\$6.2 - \$92.5		

**Table 6.4 SO<sub>2</sub> Control Costs for Dry FGD Applied to Dry Kilns and Preheater Kilns  
 (2006 dollars)**

Unit Relative Size	Dry Kiln			Preheater Kiln		
	Capital Costs (10 <sup>6</sup> \$)	Annual Operating Costs (10 <sup>6</sup> \$)	SO <sub>2</sub> Cost Effectiveness (\$/ton SO <sub>2</sub> reduction)	Capital Costs (10 <sup>6</sup> \$)	Annual Operating Costs (10 <sup>6</sup> \$)	SO <sub>2</sub> Cost Effectiveness (\$/ton SO <sub>2</sub> reduction)
Small	\$1.45 – \$37.0	\$3 - \$9	\$1,900 - \$7,000	\$0.9 - \$26.3	\$0.9 – \$21.0	\$10,000- \$72,800
Medium	\$2.9 - \$84.9	\$5.5 - \$20.0		\$1.8 - \$52.6		
Large	\$5.6 - \$165.5	\$10.7 – \$38.9		\$3.6 - \$105.2		

The LADCO region had no wet kilns so cost estimates were not available for those type kilns. For the purposes of this study, wet kiln cost effectiveness is assumed to be similar to that for long dry kilns.

Additional details concerning the calculation of cost effectiveness of controls for kilns is located in a document developed by MACTEC for LADCO titled: *Cement Best Available Retrofit Technology (BART) Engineering Analysis*. This document can be downloaded from the web at the following location:

[http://www.ladco.org/reports/rpo/Regional%20Air%20Quality/BART/Cement\\_BART\\_Engineering%20Analysis%20%2B%20Appendix%20A1.pdf](http://www.ladco.org/reports/rpo/Regional%20Air%20Quality/BART/Cement_BART_Engineering%20Analysis%20%2B%20Appendix%20A1.pdf).

### **Time Necessary for Compliance**

Generally, sources are given a 2-4 year phase-in period to comply with new rules. Under the NO<sub>x</sub> SIP Call for Phase I sources, EPA provided a compliance date of about 3½ years from the SIP submittal date. Most MACT standards allow a 3-year compliance period. Under Phase II of the NO<sub>x</sub> SIP Call, EPA provided a 2-year period after the SIP submittal date for compliance. States generally provided a 2-year period for compliance with RACT rules. For BART control measures, the proposed BART guidelines require States to establish enforceable limits and require compliance with the BART emission limitations no later than 5 years after EPA approves the regional haze SIP.

For the purposes of this review, we have assumed that a 2-year period after SIP submittal is adequate for pre-combustion controls (fuel switching or cleaning) and a three year period for the installation of post combustion controls.

### **Energy and Non-Air Impacts**

Fuel switching and cleaning and process changes do not significantly impact efficiency of the cement operation, but may add to transportation issues and secondary environmental impacts from waste disposal and material handling operations (e.g. fugitive dust). FGD systems typically operate with high pressure drops across the control equipment, resulting in a significant amount of electricity required to operate blowers and circulation pumps. In addition, some combinations

of FGD technology and plant configuration may require flue gas reheating to prevent physical damage to equipment, resulting in higher fuel usage.

### Environmental Impacts

The primary environmental impact of AFGD is the generation of byproduct gypsum. While gypsum is generated as a byproduct, the intent of the AFGD system is to produce gypsum that is commercial grade that can be sold. In the case of cement kilns, production of gypsum would result in some cost offsets since gypsum is a component of Portland cement. Thus the gypsum produced could be used to offset gypsum purchases.

The primary environmental impact of wet scrubbers is the generation of wastewater and sludge. Waste from wet scrubbers will increase the sulfate and solids loading in the facility's wastewater. This places additional burdens on a facility's wastewater treatment and solid waste management capabilities. These impacts will need to be analyzed on a site-specific basis. If lime or limestone scrubbing is used to produce calcium sulfite sludge, the sludge is water-laden, and it must be stabilized for land filling. If lime or limestone scrubbing is used to produce calcium sulfate sludge, it is stable and easy to dewater. However, control costs will be higher because additional equipment is required. Scrubber exhaust gases are saturated with water, thus creating a visible plume. Plume visibility may be a local/community concern. Once the exhaust mixes with sufficient air, the moisture droplets evaporate, and the plume is no longer visible.

Disposal of removed material from dry FGD systems is also required and will result in landfill impacts.

### Energy Impacts

A scrubber operates with a high pressure drop, resulting in a significant amount of electricity required to operate the blower and pump. In addition for some technologies, a flue gas reheater may be required resulting in slightly increased fuel usage.

### Remaining Useful Life of the Source

MACTEC could find little information on the typical lifetime of a cement plant. In a Security and Exchange filing (<http://www.sec.gov/edgar/disclosure/procurement/prosmcldopr.html>) for a facility in India, typical lifetimes of various components of the plant range between 20-50 years. In an evaluation of waste management of cement kiln dust (CKD), remaining useful lifetimes of waste management units were around 20 years (<http://www.epa.gov/epaoswer/other/ckd/rtc/chap-4.pdf>). Thus we found nothing to suggest that the amortization of capital costs or calculation of annual operating costs would be affected by the remaining useful life.

For the purposes of this analysis, we assumed that the remaining useful life of each emission unit was a minimum of at least 10 years and that it was likely that some units would continue to operate for at least 20-30 more years with proper maintenance and upkeep.

## REFERENCES

*Assessment of Control Technology Options for BART-Eligible Sources*, NESCAUM, March 2005.

EPA. January, 1995. AP42 Section 11.6 – “Portland Cement Manufacturing”.

Hansen, Eric R. *Staged Combustion for NO<sub>x</sub> Reduction Using High Pressure Air Injection*, IEEE-IAS/PCA 43rd Cement Industry Technical Conference; Jacksonville, FL: May 2002.

Miller, F.M. et. al. *Formation and Techniques of Control of Sulfur Dioxide and Other Sulfur Compounds in Portland Cement Kiln Systems*. Portland Cement Association R&D Serial No. 2460, 2001.

Tanna, B. and B. Schipholt. *Waste-Derived Fuel Use in Cement Kilns* ERAtch Group, LLC <http://www.eratech.com/papers/wdf.htm>, accessed September, 2004.

This page left blank intentionally.

## CHAPTER 7

### ANALYSIS OF SELECTED KILNS

#### SOURCE CATEGORY DESCRIPTION

Emission control regulations for cement kilns have historically focused on particulate emissions. Over the past several years, regulations for the control of NO<sub>x</sub> and hazardous air pollutant (HAP) emissions have also been adopted. SO<sub>2</sub> emission controls are largely non-existent. Some States have mandated emission limits as part of the Title V requirements but no national regulatory program for SO<sub>2</sub> controls for cement kilns exists. The only exceptions to this is for sources subject to New Source Review under Title I of the Clean Air Act and for sources subject to the Best Available Retrofit Technology (BART) requirements of the regional haze regulations.

Title I subjects new and modified large stationary sources that increase their emissions to permitting requirements that impose control technologies of varying levels of stringency (known as New Source Review, or NSR). NSR prescribes control technologies for new plants and for plant modifications that result in a significant increase in emissions, subjecting them to Best Available Control Technology (BACT) in attainment areas and to the Lowest Achievable Emission Rate (LAER) in nonattainment areas. The control strategies that constitute BACT and LAER evolve over time and are reviewed on a case-by-case basis in State permitting proceedings.

#### INFORMATION OBTAINED FROM STATE AGENCIES

MACTEC contacted State agencies to obtain information on kilns from those facilities in the list of the top 20 individual non-EGU sources. We requested permit information, information about SO<sub>2</sub> controls recently implemented or planned at the facility and any available information on BART, consent decrees, or other regulations that will impact control devices at the facilities. The information we obtained is included in Table 7.1.

**Table 7.1 Point Source Information Collected from the Top 3 Kilns Responsible for Visibility Impairment in MANE-VU Class I Areas**

Facility Name	State	2002 SO <sub>2</sub> Total (tons)	Primary Emissions Point Description	Point ID (Permit ID No.)	Design Capacity	Existing Control(s)	Proposed/Planned Control(s)	Additional Information
LaFarge Building Materials Inc. <sup>1</sup>	NY	14,800	Two rotary, wet process kilns (Kiln 1 & 2) and two clinker coolers (Clinker Cooler 1 & 2). There are buildings at either end of the kilns; the discharge end building where the clinker coolers are located, and the feed end building.	041000	Unknown	Fabric filter dust collector on clinker coolers (PM) ESP (PM)	None	
St. Lawrence Cement Corp. – Catskill Quarry <sup>2,3</sup>	NY	3,562	Cement kiln permitted to burn coal, oil, tires, waste oil, natural gas, non-hazardous fuels, and coke. This is a wet kiln built in 1964.	U00K18	Unknown	ESP	Low-sulfur fuel	Consent Decree dated 1/9/91 limits burning solid fuel with a max sulfur content of 3.8 lbs/MMBTU/hr. BART analysis has not been completed.
Lafarge Midwest, Inc., Alpena Plant <sup>4</sup>	MI	16,576	Five rotary dry kilns, clinker coolers and associated materials handling operations. Kilns fire with coal, coke or waste derived fuel	EU-Kiln19 EU-Kiln20 EU-Kiln21 EU-Kiln22 EU-Kiln23	Unknown	Baghouses on kiln dust return systems	Unknown as of date of report - these units are subject to BART	SO <sub>2</sub> Emission limits on all five kilns: EUKiln19 = 2,088 tons EUKiln20 = 2,065 tons EUKiln21 = 2,056 tons EUKiln22 = 9,685 tons EUKiln23 = 9,728 tons

<sup>1</sup> New York State Department of Environmental Conservation, Division of Air Resources. Personal communication regarding LaFarge Building Materials Incorporated facility between Mr. Rick Leone (518-402-8403) and Ms. Lori Cress, MACTEC Federal Programs, Inc., on February 2, 2007.

<sup>2</sup> New York State Department of Environmental Conservation, Division of Air Resources. Personal communication regarding St. Lawrence Cement Corporation – Catskill Quarry facility between Mr. Rick Leone (518-402-8403) and Ms. Lori Cress, MACTEC Federal Programs, Inc., on February 9, 2007.



- <sup>3</sup> New York State Department of Environmental Conservation, Division of Air Resources. Personal communication regarding St. Lawrence Cement Corporation – Catskill Quarry facility from Mr. Rick Leone (518-402-8403) via E-mail on February 9, 2007.
- <sup>4</sup> Michigan Department of Environmental Quality, Air Quality Division. Personal communication regarding LaFarge Midwest, Incorporated Alpena Plant from Ms. Teresa Walker (517-335-2247, [walkertr@michigan.gov](mailto:walkertr@michigan.gov)) via E-mail on February 7, 2007.

This page left blank intentionally.

## CHAPTER 8

### HEATING OIL

#### BACKGROUND

Number 2 distillate fuel oil, heating oil, and diesel fuel oil are essentially the same refinery-produced liquid. In the Northeast United States, home heating accounts for 54% of distillate fuel oil demand. In comparison, highway diesel accounts for 38% (NESCAUM, 2005). Annually, home heating oil use generates an estimated 100,000 tons of sulfur dioxide (SO<sub>2</sub>) emissions in the Northeast (NESCAUM, 2005). Climate and seasonality play important roles in the use of heating oil, and therefore the emissions from combustion of heating oil. While it is important to consider the emissions from heating oil in the Northeast United States, emissions from heating oil combustion in other areas of the United States such as the VISTAS States are not significant in comparison to other emission sources.

SO<sub>2</sub> emissions are proportional to fuel oil sulfur content. It is not feasible to control SO<sub>2</sub> emissions from homes using control devices; therefore, the most efficient method for controlling SO<sub>2</sub> emissions from home heating is by lowering the amount of sulfur in the fuel. Currently, the sulfur limits in heating oil vary between 2,000 to 20,000 ppm. Table 8.1 provides information on the range of sulfur in heating oils throughout the Northeast.

**Table 8.1 State Sulfur Limits for Heating Oil**

State	Sulfur Limit in Percent	Sulfur Limit in parts per million (ppm)
Connecticut	0.3	3,000
Maine	0.3 to 0.5	3,000 to 5,000
Massachusetts	0.3	3,000
New Hampshire	0.4	4,000
New Jersey	0.2 to 0.3	2,000 to 3,000
New York Upstate	1.0 to 1.5	10,000 to 15,000
New York Downstate	0.2 to 0.37	2,000 to 3,700
Rhode Island	0.5	5,000
Vermont	2.0	20,000

Source: NESCAUM, 2005

Beginning in 2006, the permissible level of sulfur in highway diesel fuel (ultra low sulfur diesel, or ULSD) was 15 ppm. Prior to that, highway low sulfur diesel fuel was refined to contain 500 ppm sulfur (Low Sulfur Diesel, or LSD). Consequently, refineries have already performed the capital investments required for the production of LSD and ULSD fuel oil. The Northeast States are considering adopting consistent low sulfur heating oil requirements, and a memorandum titled *DRAFT Memorandum of Understanding for Regional Fuel Sulfur Content Standards for*

*Distillate Number 2 Heating Oil*, the Northeast States proposed to reduce the sulfur content to 500 ppm. A reduction of sulfur in heating oils from the current levels to 500 ppm would reduce SO<sub>2</sub> emissions by approximately 75% per year on a nationwide basis (Bačey and McDonald, 2005). There has also been some discussion regarding the reduction of heating oil sulfur content to 15 ppm.

This memorandum presents the four factor analysis that was applied to the heating oil sulfur reduction proposal. The four factors are: cost of compliance, time necessary for compliance, energy and non-air impacts, and remaining useful life of the sources. This document primarily focuses on reducing the sulfur content of heating oil to 500 ppm. Information on reducing the sulfur content of heating oil to 15 ppm is presented wherever data were available.

#### **FOUR FACTOR ANALYSIS OF POTENTIAL CONTROL SCENARIOS FOR EMISSIONS FROM HEATING OIL COMBUSTION**

##### **Cost of Compliance**

##### **Refinery Retrofit Costs**

Refineries were required to make significant capital investments to meet the LSD and ULSD highway fuel sulfur requirement. To achieve the LSD and ULSD sulfur goals, refineries were required to implement diesel desulfurization technologies. Estimates for the capital costs were developed in 2001 by the Energy Information Administration (EIA) and are based on calendar year 1999. Table 8.2 presents the capital costs for desulfurization technologies developed by the EIA, which were converted from a calendar year 1999 dollar basis to 2006 dollars. The EIA developed estimates for new and revamped desulfurization technologies at existing refineries.

**Table 8.2 Ultra Low Sulfur Diesel (ULSD) Desulfurization Technology Costs for Individual Refineries<sup>a,b</sup>**

<b>Desulfurization Unit Type</b>	<b>Throughput (Barrels per Day)</b>	<b>Capital Costs (2006 Dollars per Daily Barrel Produced)</b>	<b>Total Capital Cost per Unit (Million 2006 Dollars)</b>
New	50,000	1,204	60.3
New	10,000	2,187	21.9
Revamp	50,000	716	35.8
Revamp	10,000	1,464	14.6

<sup>a</sup>Based on cost estimates for hydrotreaters to produce ULSD.

<sup>b</sup>Source for this information is the Energy Information Administration

Note – A conversion factor of 1.2101 was used to convert the dollar values from 1999 to 2006  
[www.inflationdata.com](http://www.inflationdata.com)

In its highway diesel fuel rulemaking, EPA also developed cost estimates for the deployment and implementation of desulfurization technologies at refineries. EPA estimated that it would cost existing refineries an estimated \$56 million (2006 dollars) per refinery to install desulfurization

technologies, and that this effort would be spread out over a 2-year time period. EPA based its conclusions on the assumption that refineries would revamp their hydrotreating technologies. It further estimated that 80% of the hydrotreaters at the refineries would be revamped. The EPA also estimated that the cost of a new hydrotreater would be \$91 million (2006 dollars), and that roughly 25 refineries nationwide would have to make this investment. No estimates were made for the costs associated with new refineries as none are currently being constructed in the United States. The EPA analysis spread the investment cost over a 2-year period. Consequently, it was estimated that the US refinery-wide investment for calendar year 2004 was \$2.45 billion and \$2.83 billion for calendar year 2005 (EIA 2001) (Converted from 2001 to 2006 dollars using a conversion factor of 1.1383. [www.inflationdata.com](http://www.inflationdata.com)).

In the August 9, 2006 edition of *This Week in Petroleum*, EIA reported that total ULSD production progress has been good and that ULSD is currently being produced in all Petroleum Administration for Defense Districts (PADDs). Stocks of ULSD in the United States in January 2007 were approximately equal to distillate oil containing greater than 500 ppm sulfur. However on the East Coast, stocks of ULSD were approximately one-third the size of distillate oil stocks containing more than 500 ppm sulfur (EIA). Another independent source, The Marathon Petroleum Company, LLC, found that 90% of refineries in the continental United States that were included in a survey had designed units capable of producing ULSD. Also, Marathon determined that the planned US capacity for ULSD would be in excess of 2.5 million barrels per day in 2006 (Marathon Petroleum Corporation 2007).

### Heating Oil Cost Increases

It is assumed that the costs for retrofitting refineries will be passed on to consumers. In its December 2005 study, NESCAUM estimated that the average price increment for the lower sulfur product (500 ppm) would be \$0.16 per gallon. In December 2005, this represented a 1% increase of the average oil price.

To update these costs we compared the costs of low-sulfur diesel fuel (15 – 500 ppm) with regular diesel fuel (2,000 ppm) for 2006. These data were gathered from DOE EIA Web site on March 8, 2007. We used the difference in diesel fuel prices because the cost for low sulfur heating oil is currently not reported and because diesel fuel and number 2 distillate are essentially the same product. It is therefore reasonable to assume that the cost differential between low sulfur and regular diesel fuel should reflect the potential cost differential between low sulfur and regular heating oil. All cost comparisons are before taxes. EIA only reports a low-sulfur diesel fuel category which includes both low sulfur (500 ppm) and ultra low sulfur diesel (15 ppm). For the first two months on 2007, EIA reports that stocks of 15 ppm sulfur oil were roughly twice that of 500 ppm sulfur oil. We averaged monthly costs to compute annual average costs for PADD 1A (CT, ME, MA, NH, RI, VT) and PADD 1B (DE, DC, MD, NJ, NY, PA) for low sulfur and regular diesel fuel from January to December 2006. For PADD 1A, the cost of low sulfur diesel fuel ranged from \$1.954 to \$2.433 per gallon and the cost of regular diesel fuel ranged from \$1.963 to \$2.429 per gallon. The monthly difference between low sulfur and regular diesel fuel ranged from -1.1 cents per gallon to 0.5 cents per gallon with an annual average of -0.8 cents per gallon. That is, low-sulfur diesel fuel was on average less expensive than regular diesel fuel in PADD 1A in 2006. Similarly in PADD 1B, the cost of low sulfur diesel fuel ranged from \$1.894 to \$2.358 per gallon and the cost of regular diesel fuel ranged

from \$1.894 to \$2.321 per gallon. The monthly difference between low sulfur and regular diesel fuel ranged from -1.3 cents per gallon to 4.7 cents per gallon with an annual average of 1.6 cents per gallon. In both regions fuel costs were highest in the summer and the difference in cost between low sulfur and regular diesel fuel was also highest in summer. To calculate an average cost differential, we weighed the PADD 1A and PADD 1B cost differentials by residential fuel use in each PADD for 2005 (the latest date data are available from EIA). In 2005, PADD 1A States used 1.9 million gallons and PADD 1B States used 2.5 million gallons. Therefore, on average low sulfur distillate oil would be expected cost 0.8 cents per gallon more than regular heating oil in MANE-VU States. This average price differential translates in to \$734/ton of sulfur removed if it assumed that the low sulfur diesel has a concentration of 500 ppm sulfur or \$554/ton of sulfur removed for ultra low 15 ppm sulfur diesel.

STAPPA-ALAPCO (2006) estimates that the annual fuel oil consumption per household is 865 gallons per year. Using the price differential data presented above, the average household would spend about \$7 per year additional on home heating costs by using low or ultra low sulfur fuel.

The use of LSD/ULSD will also result in cost savings to owners/operators of residential furnaces and boilers due to reduced maintenance costs. When the existing heating oil sulfur content is 2,000 ppm and 500 ppm sulfur is substituted, the service interval can be extended by a factor of three or more (e.g., cleaning at three year intervals rather than annually). Vacuums are used to remove deposition caused by SO<sub>2</sub> from furnaces and boilers.

The potential vacuum cleaning costs savings for the United States, for a starting fuel sulfur content of 2,000 ppm ranges from approximately \$200 million a year to \$390 million a year for service costs of \$50 to \$100 per hour. Therefore, if all oil heated homes switched to 500 ppm sulfur heating oil, more than \$200 million a year could be saved, which would significantly lower the overall operating costs of fuel oil marketers. Given the dominant share of the U.S. heating oil market represented by the Northeast States, a large percentage of the projected national benefits would accrue in the region (NESCAUM 2005). In a brochure distributed by EIA titled *Residential Heating Oil Prices: What Consumers Should Know*, EIA reports that 6.3 million of the 8.1 million households using heating oil in the United States (78%) are in the Northeast Region. This region includes the New England and Central Atlantic States.

### Heating Oil Supply

EPA addressed the issue of using ULSD for heating oil purposes in its regulatory impact analysis for Heavy-Duty Engine and Vehicle Standards and Highway Diesel Fuel Sulfur Control Requirements (2000). EPA found that refiners in the Mid-Atlantic and Northeast (PADD 1) could produce more of this fuel and reduce the need for imports.

EIA reports that in 2004, 5,975,966,000 gallons of heating oil were sold in the United States. This decreased to 5,548,827,000 gallons in 2005. The EIA publishes weekly updates on the availability of heating oil. Information was retrieved for January 2007 and is summarized in Table 8.3 below.

**Table 8.3 Average January 2007 Distillate Stocks  
 (Million Barrels)<sup>a</sup>**

Location	15 ppm and Under Stocks	15 ppm -- 500 ppm Stocks	>500 ppm Stocks	Total Distillate Stocks
US (Total)	57.2	25.0	59.7	141.8
East Coast	14.7	21.9	44.5	66.5
Average Days of Supply of Distillate Fuel Oil <sup>b</sup>	34.4	34.4	34.4	34.4

<sup>a</sup>Source for this information is the Energy Information Administration.

<sup>b</sup>The sulfur content of distillate stocks is not distinguished by the EIA for this data point.

The EIA also makes available information regarding the production and imports of heating oil. This information is summarized in Table 8.4, and includes specific data for the East Coast.

The information presented in Table 8.4 indicates that on a nationwide basis, more ULSD is produced than both LSD and high sulfur fuel. This is due to the predominant use of ULSD in highway diesel vehicles. This information also supports the conclusion that the United States has the infrastructure to produce adequate stocks of LSD and ULSD.

**Table 8.4 Distillate Production and Imports  
 (Million Barrels per Day)<sup>a,b</sup>**

Location	15 ppm and Under Production	15 ppm - 500 ppm Production	>500 ppm Production	Total Distillate Production
US	2.659	0.624	0.970	4.253
East Coast	0.248	0.024	0.277	0.549
Imports	0.204	0.018	0.115	0.392

<sup>a</sup>Source for this information is the Energy Information Administration.

<sup>b</sup>Based on the four week average ending January 12, 2007.

Currently, the 15 ppm fuel is sold for highway use diesel, whereas the >500 ppm stocks are sold for heating oil. The 15-500 ppm fuel can still be used until 2010 under the hardship provisions of the heavy duty highway diesel program (EPA 2004). Under these provisions of the heavy duty highway diesel program, if there is a shortage of 15 ppm fuel, the 15 -500 ppm fuel could be used to relieve the shortage. With this flexibility, the likelihood of a fuel shortage in the short term, due to usage of ULSD for heating oil is reduced.

### **Time Necessary for Compliance**

Refiners in the United States are already producing low sulfur highway diesel fuel. This same fuel can be marketed as heating oil since it is the same refinery product as highway diesel except with dye added to the fuel to differentiate it for tax purposes. Some time may be required to

allow petroleum marketers to adjust to distributing ULSD to heating oil customers, however, the distribution network for motor fuels and heating oil are already in place.

NESCAUM (2005) estimated that during peak periods of demand, up to 20% of the required heating oil is imported. This analysis does not address whether offshore refineries should be able to produce 15 ppm sulfur for export to the Northeast United States. In case of a shortage of 15 ppm fuel during the transition period from LSD to ULSD, the heavy duty highway diesel program allows the use of 15-500 ppm sulfur fuel.

Existing residential furnaces and boilers do not need to be retrofitted or modified to combust 15 ppm sulfur. The capacity for producing LSD and ULSD already exists among US refiners. Consequently, the time necessary for compliance does not hinge on the heating oil furnace/boiler.

### **Energy and Non-Air Impacts**

Reducing the sulfur contents of heating oil has a variety of beneficial consequences for residential furnaces and boilers. Low sulfur distillate fuel is cleaner burning and emits less particulate matter which reduces the rate of fouling of heating units substantially and permits longer time intervals between cleanings. According to a study conducted by the New York State Energy Research and Development Authority, (NYSERDA), boiler deposits are reduced by a factor of two by lowering the fuel sulfur content from 1,400 ppm to 500 ppm. These reductions in buildup of deposits result in longer service intervals between cleanings. (Batey and McDonald 2005). Batey and McDonald (2005) estimated that the potential cost savings from decreased vacuum cleanings ranges from \$200 million per year to \$390 million per year. The decreased deposits would also enable a more efficient transfer of heat, thereby reducing the fuel usage. Further reducing the heating oil sulfur from 500 to 15 ppm would increase the cost savings from decreased maintenance needs due to heat exchanger fouling.

The decreased sulfur levels would enable manufacturers to develop more efficient furnaces and boilers by using more advanced condensing furnaces and boilers. These boilers recoup energy that is normally lost to the heating of water vapor in the exhaust gases. Historically, the use of high sulfur fuels prevented this due to the corrosion of the furnace/boiler due to the creation of sulfuric acid in the exhaust gases. The increased efficiency results in a decrease in the amount of heating oil a heating unit uses, therefore, this would make a switch to lower sulfur heating oils more attractive and cost effective.

### **Remaining Useful Life of the Source**

Residential furnaces and boilers have finite life times, but they do not need to be replaced to burn low or ultra low sulfur fuel. The Energy Research Center estimates that the average life expectancy of a residential heating oil furnace is approximately 18 years, and that the average life expectancy of a residential heating oil boiler is 20-25 years (Personal communication with Mr. John Batey, Energy Research Center on February 6, 2007).

Finally, the number of homes that are being heated with heating oil is declining by approximately 100,000/year (RedOrbit 2007). No geographical distribution was available for



this estimate, but since heating oil is predominantly used in the Northeast, most of the changes will be occurring there. Consequently, emissions from heating oil combustion will become less significant of a source of SO<sub>2</sub> emissions in the future.

## REFERENCES

Batey, J.E. and R. McDonald, 2005. *Low Sulfur Home Heating Oil Demonstration Project Summary Report*. Project funded by The New York State Energy Research and Development Authority. Contract No. 6204-IABR-BR-00.

Energy Research Center. Personal communication on February 6, 2007 with Mr. John Batey and Mr. Bernd Haneke of MACTEC Federal Programs, Inc.

EPA, 2004. *Overview of EPA's Low Sulfur Diesel Fuel Programs*. Presented at the Ultra-Low Sulfur Diesel Fuel Implementation Workshop by the EPA's Office of Transportation and Air Quality, New Orleans, Louisiana, November 15, 2004.

Marathon Petroleum Company, LLC. Ultra Low Sulfur Diesel. PowerPoint Presentation downloaded from the World Wide Web on January 31, 2007 from:  
<http://www.marathonpetroleum.com/>

NESCAUM, 2005. *Low Sulfur Heating Oil in the Northeast States: An Overview of Benefits, Costs and Implementation Issues*.

RedOrbit, 2007. *Refiners Have Many Options to Convert High-Aromatic Streams into ULSD*. Article downloaded from the World Wide Web on January 31, 2007 at: <http://www.redorbit.com>

STAPPA ALAPCO, 2006. *Controlling Fine Particulate Matter Under the Clean Air Act: A Menu of Options*.

US Energy Information Administration, August 9, 2006. *This Week in Petroleum*.

US Energy Information Administration, 2001. Brochure titled *Residential Heating Oil Prices: What Consumers Should Know*.

US Energy Information Administration, 2001. The Transition to Ultra-Low –Sulfur Diesel Fuel: Effects on Prices and Supply. Publication downloaded from the World Wide Web on January 31, 2007 at: [www.eia.doe.gov/oiaf/servicerpt/ulsd](http://www.eia.doe.gov/oiaf/servicerpt/ulsd)

US Energy Information Administration, 2007. Information downloaded from the World Wide Web on March 8, 2007 at: [http://tonto.eia.doe.gov/dnav/pet/pet\\_pri\\_dist\\_dc\\_u\\_R1X\\_m.htm](http://tonto.eia.doe.gov/dnav/pet/pet_pri_dist_dc_u_R1X_m.htm)

US EPA, 2000. Regulatory Impact Analysis: *Heavy Duty Engine and Vehicle Standards and Highway Diesel Fuel Sulfur Control Requirements*. EPA Publication Number EPA420-R-00-026.

## CHAPTER 9

### RESIDENTIAL WOOD COMBUSTION

#### BACKGROUND

The MANE-VU Contribution Assessment and other MANE-VU reports have documented that visibility impairment in this region is primarily due to regional secondary sulfate. However, in the MANE-VU Class I areas, biomass combustion also has been identified as a contributor to visibility impairment. Biomass combustion emissions due to human activity primarily derive from residential wood combustion. While some biomass burning occurs throughout the year, residential wood combustion occurs predominantly in the winter months, potentially contributing to wintertime peaks in PM concentrations.

In the document, *Control Analysis and Documentation for Residential Wood Combustion in the MANE-VU Region*, OMNI Environmental Services, Inc. (OMNI) conducted a control analysis and documentation of residential wood combustion (RWC) in the 11 States and the District of Columbia that make up the MANE-VU region. Information for the OMNI analysis was obtained from: (1) The MANE-VU Residential Wood Combustion Emission Inventory published by MARAMA (July 2004 report), (2) Residential Energy Consumption Surveys published by the EIA, (3) the National Emission Inventory published by the EPA, (4) Simmons Marketing Research reports, and (5) American Housing Surveys for the United States published by the U.S. Department of Commerce and the U.S. Department of Housing and Urban Development. In addition, the results of three RWC surveys at the State-level have been published in the last decade for the Mid-Atlantic and New England area, which allow for comparison of data extrapolated from the national- and regional-scale surveys to the State level for three States. These were the: (1) 1995 Delaware Fuelwood Survey, (2) Residential Fuelwood Use in Maine, Results of 1998/1999 Fuelwood Survey, and (3) Vermont Residential Fuel Wood Assessment for 1997-1998.

To facilitate understanding of the cost effectiveness analyses done by OMNI, descriptions of the various appliances used, as well as a brief discussion of efficiency, are provided from the OMNI report.

#### **Cordwood-Fired Stoves and Fireplace Inserts**

Uncertified, certified catalytic, and certified non-catalytic cordwood stoves and fireplace inserts together are considered cordwood heaters. They are designed to burn bulk cordwood and are room space heaters, i.e., they primarily rely on radiant and convection heat transfer, in contrast to centralized heating systems such as warm-air furnaces or boilers which utilize heat distribution systems to heat multiple rooms. Fireplace inserts are essentially wood stoves that are designed to be inserted into an existing fireplace cavity. Because of the heat transfer shielding effect of the fireplace cavity and the fact the majority of existing fireplace chimneys are against an outside wall, their heating efficiency is less than a similar freestanding woodstove. Many fireplace inserts have fans to facilitate transfer of heat from the portion that is inside the fireplace cavity. Both freestanding cordwood stoves and fireplace inserts rely on a natural draft using room air for combustion and the venting of exhaust through the chimney to the atmosphere. Though the

majority of cordwood heaters use room air for combustion, some insert installations, such as in mobile homes, require the use of outside air for combustion.

#### **Uncertified Conventional Cordwood-Fired Stoves and Fireplace Inserts**

Uncertified cordwood fired stoves and fireplace inserts include units manufactured before the 40 CFR Part 60, Subpart AAA New Source Performance Standard (NSPS) July 1, 1990 certification requirement, and currently or recently manufactured exempt units which operate similarly to some old pre-EPA certification units.

#### **NSPS Certified Catalytic Cordwood-Fired Stoves and Fireplace Inserts**

Certified catalytic units pass the exhaust through a catalyst to achieve emission reductions. Generally, a coated ceramic honeycomb catalyst is located inside the stove where the incompletely combusted gases and particles ignite and are combusted further, thus reducing air emissions and increasing combustion overall efficiency.

#### **NSPS Certified Non-Catalytic Cordwood-Fired Stoves and Fireplace Inserts**

Certified non-catalytic stoves and fireplace inserts rely on design features to reduce air emission and increase efficiency. They generally rely on the introduction of heated secondary air to improve combustion, as well as firebox insulation, and baffles to produce a longer, hotter gas flow path, as well as other design features to achieve low emissions and higher efficiency.

#### **Pellet Stoves and Fireplace Inserts**

Analogous to cordwood stoves and fireplace inserts, pellet stoves and fireplace inserts are considered room heaters. They burn pellets generally made from sawdust, although there has been, and continues to be, research into utilizing other biomass fuels to make pellets. Combustion air is drawn from the room for most models, and exhaust is vented outdoors. Some pellet appliances use outside air for combustion. Pellet stoves and inserts require the use of electric motors to power the combustion air and heat transfer fans and the pellet-feeding auger. Modern pellet units use electronic sensors and controls. Pellets are introduced into the hopper, and the auger continuously feeds a consistent amount of pellets into the firebox. The feed rate is controlled electronically by a feed rate setting selected by the user. There are two basic designs: bottom-feed and top-feed models. Pellet units have a high efficiency and low emissions due to the use of the electric auger and fan that produce uniform and controlled combustion conditions. Some units are certified by the NSPS process and some are not. The performance of the certified and uncertified models are similar. What is considered by most as a "loop-hole" in the NSPS regulations essentially allows certification to be bypassed.

#### **Wood-burning Fireplaces without Inserts**

Fireplaces without inserts include manufactured units (often referred to as "zero-clearance" fireplaces) and site-built masonry units operated both with and without glass doors. Combustion air is drawn from the natural draft created by fire, and that same draft vents the exhaust gases through the chimney. Fireplaces without inserts have low efficiencies due to the large amount of heated room air that is exhausted out of the chimney from the draft. Many fireplaces without inserts are not used in a given year, some are used for aesthetic purposes and some are used for

heating. Those that are used for heating are almost always used for secondary heating purposes and not primary heating due to their low efficiency and lack of heat transfer capabilities. Manufactured wax/fiber firelogs are often used as a fuel in them with about 30% of fireplace users nationwide claiming that they use wax/fiber firelogs some of the time. Most fireplaces are wall-mounted, however, this category also includes some free-standing models.

### **Direct Vent Gas Stoves and Fireplace Inserts (LPG and Natural Gas)**

Direct vent gas stoves and inserts are sealed units that draw their combustion air from, and vent their exhaust to, the outside air. Venting can be extended vertically or horizontally out of the home. A common type of venting is coaxial, which has the exhaust pipe contained within the air inlet pipe, so the temperature of the combustion air is raised, and the temperature of the exhaust is lowered, creating more efficient combustion. It should be noted that natural gas is not readily available in all locations, however LPG may be available for use.

### **Vent-Free Gas Stoves and Fireplace Inserts (LPG and Natural Gas)**

Vent-free gas stoves and inserts receive their combustion air from the room in which the unit is placed, and all of the products of combustion are exhausted into the room as well. The high efficiency of vent free units is due to the fact that the heat produced is kept in the room. Vent free gas stoves and inserts have a maximum heat input in order to avoid emitting excess CO, CO<sub>2</sub>, or NO<sub>x</sub> into the room, and the units also have an O<sub>2</sub> depletion sensor or other device to shut the unit down if oxygen levels become too low. It is important to note that vent-free natural gas and LPG stoves, inserts and log sets should not be considered options for primary or even significant secondary heating use. There is considerable concern regarding indoor air quality and damage to homes by moisture created from their use, as combustion gases are not vented to the atmosphere. If the devices are used prudently, these problems are reduced. Their appropriate role is for aesthetics and minor secondary heating. Just as with direct vent gas stoves and fireplace inserts, LPG can be used as an alternative where natural gas is not readily available.

### **B-Vent Gas Stoves and Fireplace Inserts (LPG and Natural Gas)**

B-vent gas stoves and inserts draw their combustion air from the room, and exhaust is vented outdoors. These units use a draft hood for the proper venting of exhaust. B-vent gas stoves and inserts have lower efficiency than direct vent due to the fact that already heated room air is used as combustion air, which is then exhausted to the outdoors, taking heat away from the room.

### **OMNI Study Summary**

In the OMNI study, the amount of fuel consumed by RWC devices was considered the measure of activity. Activity data were provided by individual appliance type by State and for the total MANE-VU region. The activity study conducted by OMNI showed that there were approximately 6.4 million tons of fuel burned in 2002 by RWC devices in the MANE-VU region. The majority of RWC combustion was located in New York (1.9 million tons of fuel burned) and Pennsylvania (1.4 million tons of fuel burned).

OMNI then compiled an emissions inventory by county, by State, and for the entire MANE-VU region for the 2002 base year. The dry mass of fuel (activity) for cordwood, pellets, and manufactured wax/fiber firelogs compiled in the activity task was multiplied by the applicable emission factor in the units of mass air pollutant per mass of dry fuel. The emission factors were obtained by reviewing and averaging (if multiple sources were available) data obtained from available reports and publications. PM and VOC (an ozone precursor) are the main criteria pollutants of concern for RWC and non attainment areas. The OMNI emissions inventory reported that there were 92,470 tons of total PM emissions and 87,741 tons of VOC generated from RWC devices in the MANE-VU region during the base year (2002). It should be noted that this analysis assumed that PM<sub>10</sub> was equivalent to PM. The only emissions control efficiency, and control device information available is for PM<sub>10</sub>. We have therefore assumed that data for PM<sub>10</sub> are applicable to PM<sub>2.5</sub>.

Table 9.1 from the OMNI report summarizes measures for RWC RACM developed by EPA in EPA-450/2-89-015. OMNI reported the RACM fall in three primary categories: (1) improvement of performance, (2) reducing the use of RWC devices, and (3) episodic curtailment. The effectiveness in reducing RWC emissions and a related discussion of each of the various activities are also provided in Table 9.1. In addition to the three primary categories for RWC RACM, the RACM document emphasizes the importance of public awareness in many RWC emission control programs and provides considerable information on the subject.

**Table 9.1 Summary of Measures Available for RWC RACM – PM<sub>10</sub>**

Program Elements	Estimated Effectiveness (%)	Discussion
<b>IMPROVEMENT OF PERFORMANCE</b>		
State implementation of NSPS	0	States are not expected to adopt this program element at levels that would affect program effectiveness significantly.
Ban on resale of uncertified devices	0	No credit recognized because requirement is largely unenforceable: other elements will be required to include disabling of retired used devices.
Installer Training Certification or Inspection Program	~ 5	Reduction in emissions from each new certified RWC device where either the installer is trained/certified or the installation is inspected.
Pellet stoves	90	Reduction in emissions from each new or existing conventional, uncertified RWC device replaced with a pellet stove.
	75	Reduction in emissions from each new or existing Phase II EPA certified RWC device replaced with a pellet stove.
EPA Phase II certified RWC devices	~50	Reduction in emissions from each new or existing conventional, uncertified RWC device replaced with an EPA Phase II certified RWC device.
Retrofit requirement	<5	Reduction in emissions from each existing conventional, uncertified RWC device equipped with a retrofit catalyst or pellet hopper (to maximum when all existing uncertified RWC devices have retrofit devices installed).
Accelerated changeover requirement	~50	Reduction in emissions from each existing conventional, uncertified RWC device replaced with Phase II certified device.
	100	Reduction in emissions from each existing conventional, uncertified RWC device removed and not replaced: requires existing device to be disabled and not resold.
Accelerated changeover inducement	~50	Reduction in emissions from each existing conventional, uncertified RWC device replaced with Phase II certified device.
	100	Reduction in emissions from each existing conventional, uncertified RWC device removed and not replaced: requires existing device to be disabled and not resold.

**Table 9.1 Summary of Measures Available for RWC RACM – PM<sub>10</sub>**

Program Elements	Estimated Effectiveness (%)	Discussion
Require fireplace inserts	0	No credit recognized for fireplace inserts, since inserts change use of fireplace from aesthetic to primary heat source, resulting in an increase in amount of wood combusted and higher overall emissions.
Wood moisture	<5	Reduction in total emissions from all RWC devices in the community/airshed.
Trash burning prohibition	0	No credit recognized for eliminating trash burning in RWC devices.
Weatherization of residences	<5	Reduction in total emissions from all RWC devices in the community/airshed.
Opacity limits	<5	Reduction in total emissions from all RWC devices in the community/airshed.
<b>REDUCING USE OF RWC DEVICES</b>		
Availability of alternative fuels	100	Reduction in emissions from each RWC device removed from service and replaced with device using natural gas; recognize no more than 10% of RWC devices replaced under program with no additional incentives.
Emission trading	Computation required	For a 2:1 trading ratio, the reduction in emissions from each new stove would be calculated as the difference between emissions of a new RWC device and 2 times the average emissions per stove in the community: multiplier would change for other trading ratios.
Taxes on RWC devices	Variable	Emission reduction credit would vary with utility or tax rate structure adopted and extent to which this structure resulted in reduction in number of RWC devices in the community versus reduction in use of RWC devices.
Regulatory ban on RWC devices in new dwellings	100	Reduction in emissions from new RWC devices purchased for installation in new dwellings.
Regulatory ban on existing RWC devices	100	Reduction in emissions from each RWC device removed.



**Table 9.1 Summary of Measures Available for RWC RACM – PM<sub>10</sub>**

Program Elements	Estimated Effectiveness (%)	Discussion
<b>EPISODIC CURTAILMENT</b>		
Voluntary	10	Reduction in emissions for all RWC devices not exempted.
Mandatory	60% fireplace 50% woodstoves	Reduction in emissions for all RWC devices not exempted.

Table Reference: U.S. EPA, 1992, *Technical Information Document for Residential Wood Combustion Best Available Control Measures*, Research Triangle Park, NC, EPA-450/2-92-002.

Table 9.2 from the OMNI report summarizes measures for RWC BACM developed by EPA in EPA-450/2-92-002. As shown in Table 9.2, the BACM fall into two primary categories: (1) integral measures which are necessary for the success of a long-term RWC pollutant reduction programs but, by themselves, are not adequate to provide long-term reductions and (2) flexible (long-term) measures to reduce, eliminate, or prevent increases in pollutant emissions for existing and/or new installations. With the exceptions of the device and upgrade offsets, the specific elements of the BACM are essentially those described in the RACM document with the various efficiencies listed in Table 9.1 being applicable.

**Table 9.2 Summary of Measures Available for RWC BACM – PM<sub>10</sub>**

Integral Measures <sup>1</sup>	Flexible Measures that Reduce or Eliminate Emissions from Existing Installations <sup>2</sup>	Flexible Measures that Reduce Emissions or Prevent Emission Increases from New Installations <sup>2</sup>	Flexible Measures that Reduce Emissions from New and Existing Installations <sup>2</sup>
1. Public awareness and education.	1. Conversion of existing wood-burning fireplaces to gas logs.	1. Gas fireplaces or gas logs in new wood burning fireplace installations.	1. Device offset. <sup>4</sup>
2. Mandatory curtailment during predicted periods of high PM <sub>10</sub> concentrations.	2. Changeover to EPA certified, Phase II stoves or equivalent.	2. Upgrade offset. <sup>4</sup>	2. Upgrade offset. <sup>4</sup>
3. All new stove installations EPA-certified, Phase II stoves or equivalent.	3. Changeover to low emitting device. <sup>3</sup>	3. Restriction on number and density of new wood-burning stove and/or fireplace installations.	

**Table 9.2 Summary of Measures Available for RWC BACM – PM<sub>10</sub>**

<b>Integral Measures<sup>1</sup></b>	<b>Flexible Measures that Reduce or Eliminate Emissions from Existing Installations<sup>2</sup></b>	<b>Flexible Measures that Reduce Emissions or Prevent Emission Increases from New Installations<sup>2</sup></b>	<b>Flexible Measures that Reduce Emissions from New and Existing Installations<sup>2</sup></b>
4. Measures to improve wood burning performance: -control of wood moisture content -weatherization of homes with wood stoves -educational opacity program		4. Requirement that new stove installations be low emitting.	

- <sup>1</sup> Integral measures are regarded as critical for the success of a RWC control program, but by themselves are not intended to result in long-term attainment of the PM<sub>10</sub> NAAQS for serious PM<sub>10</sub> nonattainment areas.
- <sup>2</sup> Flexible measures are designed for permanent control of RWC emissions and thus long-term attainment of the PM<sub>10</sub> NAAQS.
- <sup>3</sup> This measure is virtually identical to item 2, except that the changeover is recommended to a “low-emitting” device that can document “in-home” field test emissions less than the emission factor averages of “in-home” field test emissions data for EPA-certified stoves. This can include classes of devices that are demonstrated to be capable as a class of producing lower field emissions, as well as, specific model units that perform better in the field than the class collectively (an example might include masonry heaters, uncertified pellet-fueled devices, and wood fired gasification centralized heating systems).
- <sup>4</sup> Offsets are intended to achieve emission reductions, when retiring (device offset) or changing-out (upgrade offset) conventional stoves, greater than the emissions increase resulting from new stove installations.

Table Reference: U.S. EPA, 1992, *Technical Information Document for Residential Wood Combustion Best Available Control Measures*, Research Triangle Park, NC, EPA-450/2-92-002.

OMNI reported that the RWC RACM and BACM have been the basis for PM<sub>10</sub> innovative strategies implemented in various western States and in local jurisdictions and have also been, in large part, the basis for a number of western State and their local RWC regulations. As part of these strategies, strict particulate emission standards have been developed which will take effect in 2008.

The OMNI report states that the Washington State standard is notable among State and local regulations for residential wood burning devices. Washington State has implemented more stringent standards for residential wood burning devices, so devices installed in Washington State must be certified to the more stringent standard. This has affected the stove market because many U.S. certified stove manufacturers choose to have their appliances certified to the more stringent Washington State standard, unless the manufacturer can not or does not choose to test to the tighter standard. Discussions with EPA indicate that most manufacturers are choosing to design and sell units that meet the Washington State standards of 4.5 g/hr for non catalytic wood stoves and 2.5 g/hr for catalytic wood stoves (personal communication with Mr. John Dupree of the U.S. EPA).

## **FOUR FACTOR ANALYSIS OF POTENTIAL CONTROL SCENARIOS FOR RESIDENTIAL WOOD COMBUSTION**

### **Cost of Compliance**

OMNI analyzed the cost effectiveness of five categories of widely existing, older technology wood-burning devices. These are: (1) freestanding cordwood stoves, (2) cordwood-fueled fireplace inserts, (3) cordwood fireplaces (without inserts) used for heating purposes, (4) centralized cordwood heating systems and (5) cordwood fireplaces used for aesthetic purposes. Table 9.3 lists these five categories with the available, improved technology replacement, installation scenarios, and fuel switching alternatives that would reduce particulate and VOC emissions.

OMNI noted that wood resources are abundant and widely utilized as fuel, and heating is essential due to the climate of the region. The cost to households of any regulatory program mandating acceptable heating practices is an important consideration. Likewise, the cost to households of any voluntary program is paramount for its success. The cost effectiveness of all reasonable scenarios for the replacement, modification or alternative fuel use for older existing, high emission wood-burning appliances was provided in the OMNI report for regulators and policy makers charged with the task of specifically lowering particulate and VOC emissions from residential wood combustion.

The tables provided in this chapter based on the OMNI report allow for a direct comparison of the cost burden for each realistic mitigation option that would be shouldered by residential users. As an example, for an average resident in the MANE-VU region with an existing older technology centralized cordwood heating system, the best current option in terms of cost among the pellet, natural gas, and LPG options, is natural gas (assuming natural gas is available). Similarly, for wood-burning fireplaces used for aesthetics, manufactured wax/fiber firelogs offer the lowest cost per unit mass of air pollutant reduction. The cost effectiveness of each option is dependent on the costs of the new equipment and the cost of required fuels. The costs presented in the tables in this chapter were the most current information available as of the date of the OMNI report.

Estimates of costs per ton of reductions in the tables in this chapter are specific to the MANE-VU region because they reflect the estimated usage of various devices in this region.

**Table 9.3 Improved Technologies and Fuel Alternatives**

Existing Cordwood Device	High Technology Replacement, Installation or Alternative Fuel
Uncertified Freestanding Cordwood Stove	Replacement with Certified NSPS Non-Catalytic Cordwood Stove
	Replacement with Certified NSPS Catalytic Cordwood Stove
	Replacement with Pellet Stove
	Replacement with Gas Stove – natural gas (B vent, direct vent)
	Replacement with Gas Stove – LPG (B vent, direct vent)
Uncertified Cordwood Fireplace Insert	Replacement with Certified NSPS Non-Catalytic Cordwood Insert
	Replacement with Certified NSPS Catalytic Cordwood
	Replacement with Pellet Insert
	Replacement with Gas Insert – natural gas (B vent, direct vent)
	Replacement with Gas Insert – LPG (B vent, direct vent)
Cordwood Fireplace without Insert Used for Heating	Installation of Certified NSPS Non-Catalytic Cordwood Insert
	Installation of Certified NSPS Catalytic Cordwood Insert
	Installation of Pellet Insert
	Installation of Gas Insert – natural gas (B-vent, direct vent)
	Installation of Gas Insert – LPG (B-vent, direct vent)
Cordwood Fireplace Used for Aesthetic Purposes	Installation of Gas Log Set – natural gas (vented and vent free)
	Installation of Gas Lo g Set – LPG (vented and vent free)
	Wax/Fiber Firelog Fuel
Centralized Cordwood Heating System	Pellet Furnace or Boiler
	Gas Furnace or Boiler – natural gas
	Gas Furnace or Boiler – LPG

Table 9.4 from the OMNI report demonstrates the cost effectiveness of replacing three types of cordwood stoves and fireplaces with devices that emit less PM. Table 9.5 from the OMNI report demonstrates the impact on cost effectiveness of the same replacements on VOC reductions. The cost effectiveness tables are in reference to the replacement of an existing RWC device, and do not include new construction.

In Tables 9.4 and 9.5, if the total annual cost of the improved technology and alternative fuel replacement or installation is less than the total annual cost of the existing device, and there is corresponding pollutant reduction after installation or replacement, then there is no cost for the pollution reduction, and the cell is marked as “\*\*”. The replacement options for which there is no cost may actually represent cost savings, and thus are the most cost effective options for replacement.

**Table 9.4 PM Reduction Cost Effectiveness for Replacement of Existing Uncertified Freestanding Cordwood Stove/Insert and Cordwood Fireplace w/o Insert for Heating**

Existing Cordwood Device	Certified NSPS Non-Catalytic Cordwood Stove	Certified NSPS Catalytic Cordwood Stove	Pellet Stove	Gas Stove-NG, B Vent	Gas Stove-NG, Direct Vent	Gas Stove-LPG, B Vent	Gas Stove-LPG, Direct Vent
	PM Reduction Cost Effectiveness (\$/ton)						
Uncertified Freestanding Cordwood Stove	1.170	3.300	8,960	5,350	3,530	12,600	9,760
Uncertified Cordwood Fireplace Insert	**	**	5,180	1,910	**	8,980	6,040
Cordwood Fireplace w/o Insert for Heating	3,880	5,670	8,330	**	**	1,880	695

OMNI Environmental Services, Inc. *Task 6, Technical Memorandum 4 (Final Report), Control Analysis and Documentation for Residential Wood Combustion in the MANE-VU Region.* Project funded by Mid-Atlantic Regional Air Management Association, Inc., December 19, 2006.

\*\*No cost for the pollution reduction.

Tables 9.4 and 9.5 indicate that OMNI estimated that in the MANE-VU region there are several options for reducing emissions from two of the above types of fireplaces that would reduce emissions at essentially no cost, due to fuel cost savings.

**Table 9.5 VOC Reduction Cost Effectiveness for Replacement of Existing Uncertified Freestanding Cordwood Stove/Insert and Cordwood Fireplace w/o Insert for Heating**

Existing Cordwood Device	Certified NSPS Non-Catalytic Cordwood Stove	Certified NSPS Catalytic Cordwood Stove	Pellet Stove	Gas Stove-NG, B Vent	Gas Stove-NG, Direct Vent	Gas Stove-LPG, B Vent	Gas Stove-LPG, Direct Vent
	VOC Reduction Cost Effectiveness (\$/ton)						
Uncertified Freestanding Cordwood Stove	1,260	2,960	7,740	4,940	3,260	11,800	9,130
Uncertified Cordwood Fireplace Insert	**	**	4,480	1,760	**	8,410	5,640
Cordwood Fireplace w/o Insert for Heating	7,900	10,400	13,200	**	**	3,090	1,140

OMNI Environmental Services, Inc. *Task 6, Technical Memorandum 4 (Final Report), Control Analysis and Documentation for Residential Wood Combustion in the MANE-VU Region.* Project funded by Mid-Atlantic Regional Air Management Association, Inc., December 19, 2006.

\*\*No cost for the pollution reduction.

Table 9.6 presents the cost effectiveness in terms of dollars per ton of PM reduction and VOC reduction for replacement of an existing centralized cordwood heating system with three available technologies. The cost effectiveness tables are in reference to the replacement of an existing RWC device, and do not include new construction. The most cost effective option is replacing the existing system with a natural gas furnace or boiler. This option is not feasible in areas that do not have access to natural gas, and the increase in costs associated with using LPG is significant.

**Table 9.6 Reduction Cost Effectiveness for the Replacement of an Existing Centralized Cordwood Heating System**

High Technology Replacement, Installation or Alternative Fuel	PM Reduction Cost Effectiveness (\$/ton)	VOC Reduction Cost Effectiveness (\$/ton)
Pellet Furnaces and Boilers	7,810	17,200
Gas Furnaces and Boilers-Natural Gas	3,030	7,150
Gas Furnaces and Boilers-LPG	9,370	23,100

OMNI Environmental Services, Inc. *Task 6, Technical Memorandum 4 (Final Report), Control Analysis and Documentation for Residential Wood Combustion in the MANE-VU Region.* Project funded by Mid-Atlantic Regional Air Management Association, Inc., December 19, 2006.

Table 9.7 presents the cost effectiveness in terms of dollars per ton of PM reduction and VOC reduction for the addition of a gas log set or use of wax/fiber firelogs in an existing fireplace with

no insert. Burning wax/fiber firelogs in the existing fireplace is, by far, the most cost effective option for reducing emissions of PM and VOC.

**Table 9.7 Pollutant Reduction Cost Effectiveness for the Addition of a Gas Log Set or Use of Wax/Fiber Firelogs in an Existing Fireplace w/o Insert Used for Aesthetics**

Pollutant	Pollutant Reduction Cost Effectiveness (\$/ton)				
	Vent-Free Gas Log Set-NG	Vented Gas Log Set-NG	Vent-Free Gas Log Set-LPG	Vented Gas Log-LPG	Wax/Fiber Firelog Fuel
PM	27,100	29,900	29,400	34,100	2,530
VOC	43,900	48,500	48,300	56,600	5,110

OMNI Environmental Services, Inc. Task 6, Technical Memorandum 4 (Final Report), Control Analysis and Documentation for Residential Wood Combustion in the MANE-VU Region. Project funded by Mid-Atlantic Regional Air Management Association, Inc., December 19, 2006.

OMNI presented no cost-effectiveness summary for other RWC control measures such as described in EPA's PM<sub>10</sub> RACM/BACM guideline documents. Costs associated with these measures are predominantly organizational and administrative associated with the implementation of regulations.

**Time Necessary For Compliance**

Because the control methods discussed in the previous section for RWC are existing technology, the time necessary for compliance would depend on the amount of time it would take to regulate the sources and establish compliance deadlines. The *Feasibility Assessment of a Change-out/Education Program for Residential Wood Combustion* from the Canadian Council of Ministers of the Environment suggests a phased approach for national implementation. A phased approach will enable the program to evolve over time and benefit from lessons learned in the early stages of the program. Phasing also reflects the reality that building awareness and changing behavior is a long-term investment. The approach that this report proposed had two phases. The first phase (2005-2006) focused on building a base for support and understanding around RWC in a single province. The second phase (2007 and beyond) and full roll-out involved the realization of independent, arms length management of public education and outreach by all stakeholders throughout Canada. The main steps for this phase included:

- Implementation of national regulation as soon as possible (i.e. 2008-2009);
- Full operational capacity across Canada;
- Funding to come from multiple sources (i.e. nationwide partnerships with the insurance, financial, and utilities industries);
- Movement of various groups from being target audiences to becoming key players in designing and delivering woodstove change-out/public education campaigns; and
- Multi-stakeholder involvement and shared leadership (governments together with business and industry, communities, and non-governmental organizations).

### **Energy and Non-Air Impacts**

Other factors beyond PM<sub>2.5</sub> and regional haze (i.e., VOC and fine particles) should also influence RWC regulatory policy. The greenhouse gas benefits of biomass combustion and the minimal acid gas emissions (acid precipitation impacts) from wood combustion are strong environmental advantages. Further, the fact that wood is a domestic renewable energy source and the fact that the cost of natural gas, propane, and fuel oil have a history of rising together have been responsible for the increase in the use of RWC. For example, several States are encouraging the use of renewable energy sources such as wood for heating purposes.

The Canadian Council of Ministers of the Environment study estimated that the increase in combustion efficiency associated with a switch out to a more efficient stove would save on average more than one cord of wood per stove per heating season.

Any mandatory change out program should be mindful that even with assistance, woodstove change out programs will impact families that are least able to bear the burden of additional costs. Voluntary programs do not impose this economic burden on families less able to bear associated costs.

### **Remaining Useful Life Of The Source**

From information obtained from a scoping study that was prepared for Environment Canada in 1997, (Gulland Associates Inc., 1997) the durability of low emission stoves has improved considerably. Premature stove degradation is not viewed as a problem. In most new stoves today, vulnerable parts can be replaced, and manufacturers now use more heat-resistant materials such as ceramics and stainless steel. The performance and durability of catalytic stoves has also improved through better design and use of materials. The useful life of a wood stove catalytic element is estimated to be 9,000 to 12,000 hours, or three to five years of use, depending on heating demand, user skill, and degree of maintenance provided.

The best mechanism by which to lower smoke emissions from residential wood burning appliances is to replace conventional equipment with certified low emission stoves. Given the minimum useful life span of a wood stove of 10-15 years (per industry references), over which time the incremental cost of advanced technologies is spread, the cost impacts did not seem unreasonable to Environment Canada. It is also possible that the price of the least expensive advanced technology stove would come down after a regulation were established as manufacturers seek to fill the low cost market niche formerly filled by conventional stoves; that is, plain, unadorned styling and lacking additional features such as ash pan and large glass door panel. (Gulland Associates Inc., 1997) Many woodstove manufacturers have chosen to manufacture products at a reasonable cost that meet more stringent emissions standards such as those in Washington State (personal communication with Mr. John Dupree of EPA). Implementation of stricter emissions standards in additional states or regions will likely increase the competition to produce these woodstoves at even more reasonable prices.



## REFERENCES

OMNI Environmental Services, Inc. *Task 6, Technical Memorandum 4 (Final Report), Control Analysis and Documentation for Residential Wood Combustion in the MANE-VU Region.* Project funded by Mid-Atlantic Regional Air Management Association, Inc., December 19, 2006.

Headquarters, U.S. EPA. Personal communication regarding the number of new residential wood burning devices meeting the Washington State standards from Mr. John Dupree (202) 564-5950, (Dupree.john@epa.gov) via telephone on April 12, 2007.

U.S. EPA, 1989, *Guideline Series, Guidance Document for Residential Wood Combustion Emission Control Measures*, Research Triangle Park, NC, EPA-450/2-89-015.

U.S. EPA, 1992, *Technical Information Document for Residential Wood Combustion Best Available Control Measures*, Research Triangle Park, NC, EPA-450/2-92-002.

U.S. EPA, 1993, *PM-10 Innovative Strategies: A Sourcebook for PM-10 Control Programs*, Research Triangle Park, NC, EPA-452/R-93-016.

The Canadian Centre for Pollution Prevention, CULLBRIDG Marketing and Communications and Action-Environment, *Feasibility Assessment of a Change-out/Education Program for Residential Wood Combustion, A Step-by-Step Approach to a National Program Aimed at Reducing Emissions from Residential Wood Combustion.* September 20, 2004.

Gulland Associates Inc., *Scoping Study: Reducing Smoke Emissions From Home Heating With Wood.* Prepared for Environment Canada, March 31, 1997.

Environment Australia (2002). *Technical Report No. 4: Review of Literature on Residential Firewood Use, Wood-Smoke and Air Toxics.* 49p. Report available on the Environment Australia website  
<http://ea.gov.au/atmosphere/airtoxics/report4/exec-summary.html>.

This page left blank intentionally

## CHAPTER 10

### RESIDENTIAL WOOD COMBUSTION - OUTDOOR WOOD-FIRED BOILERS

#### BACKGROUND

Outdoor wood-fired boilers are used in the Northeast United States, and their use is increasing as more traditional heating fuels (heating oil, natural gas) are becoming more expensive. NESCAUM (2007) estimates that the sale of outdoor wood-fired boilers is increasing by 25-50% annually. Nationwide there are between 155,000 and 200,000 boilers in service (Personal communication with Lisa Rector, NESCAUM). If the sales trends continue, NESCAUM estimates that there may be up to 500,000 boilers nationally by 2010.

Outdoor wood-fired boilers are used for heating and providing hot water for both individual homes and for “mini-district heating” (Woodheat.org 2007). Additional uses of outdoor wood-fired boilers include heating swimming pools and greenhouses. Outdoor wood-fired boilers are typically located in sheds that are located near buildings. Heated water is conveyed through underground or insulated pipes.

Even though outdoor wood-fired boilers may be economical solutions to home heating and hot water production, they contribute significantly to air pollution. Outdoor boilers emit so much smoke they have been banned by some local jurisdictions (Woodheat.org 2007). NESCAUM (2007) estimates that the average fine particulate emissions from one outdoor wood-fired boiler are equivalent to the emissions from 22 US Environmental Protection Agency (EPA) certified wood stoves, 205 oil-fired furnaces, or 8,000 natural gas-fired furnaces.

On the basis of heat input, NESCAUM (2007) estimated that outdoor wood-fired boilers emit from 1.5 to 3.1 pounds of PM per MMBTU heat input. This information was calculated by NESCAUM using data from tests conducted on outdoor wood-fired boilers for EPA (EPA 1998a). (Guldberg 2007) used data from 56 outdoor wood-fired boilers tests conducted by EPA in 1995 and 1999, and estimated that outdoor wood-fired boilers emit 1.44 pounds of PM per MMBTU heat input. In comparison, the EPA estimate (EPA 1998b) for PM from residential fuel oil combustion is 0.4 pounds of PM per thousand gallons of fuel combusted. Assuming a heating value of 140 MMBTU per thousand gallons of fuel oil, the PM emission factor is 0.003 pounds of PM per MMBTU heat input for residential fuel oil combustion. Similarly, for residential natural gas combustion, (EPA 1998c) assuming a natural gas heating value of 1,020 BTU per standard cubic foot, the PM emission factor is 0.002 pounds per MMBTU heat input. Based on these emission factor estimates, and strictly on the basis of heat input, outdoor wood-fired boilers emit roughly 500 times as much PM as oil-fired residential furnaces and 750 times as much PM as natural gas-fired residential furnaces based on the low-range estimate of PM emissions from outdoor wood-fired boilers. Based on the upper range of the PM emissions estimate from outdoor wood-fired boilers, they emit roughly 1,000 times as much PM as oil-fired residential furnaces and 1,500 times as much PM as natural gas-fired furnaces.

Heavy emissions from outdoor wood-fired boilers can be attributed to their designs. For example, most outdoor wood-fired boilers have fireboxes that are surrounded by a water jacket. The water jacket makes complete combustion of the wood nearly impossible due to the cooling

effect that the jacket has on the firebox. The flaming combustion of wood cannot occur below about 540 C (1,000 F), so the steel surfaces of the water jacket backed up by water at approximately 65 C (150 F) chill and quench the flames well before complete combustion can occur.

In addition outdoor wood-fired boilers smoke heavily due to their cyclical operating pattern. When the temperature of the water within the boiler falls below a set point, its combustion air damper opens and/or a small fan forces combustion air into the firebox. Once the water is heated back to the upper set point, the fan is turned off and/or the combustion air damper closes. During the off cycles the fire smolders and much of the smoke condenses as creosote on the cold steel internal surfaces. When the thermostat again calls for heat and incoming combustion air rekindles the fire, the heat ignites the creosote clinging to the boiler walls. This leads to an increase in emissions that accompanies the poor combustion in the firebox.

Outdoor wood-fired boilers are also sometimes not sized appropriately for the house that they are intended to heat. For example, an oversized boiler will tend to run in the smoldering phase longer than in the full out burn phase, thereby producing more smoke.

It has been suggested that excessive production of emissions by outdoor wood-fired boilers is associated improper installation of the boiler or the use of fuels not designed to be combusted in the boiler (personal communication with Peter Guldberg, Tech Environmental). Additionally, Guldberg, 2007 suggests that emissions from outdoor wood-fired boilers are comparable to other wood-fired combustion devices in terms of lbs/MMBTU heat generated. In any case, Guldberg, 2007 indicates that outdoor wood-fired boiler manufacturers have worked with EPA to develop a voluntary Outdoor Wood-fired Heater Program with a Phase I emission target of 0.6 lb/MMBTU. According to Guldberg, 2007 manufacturers will offer the outdoor wood-fired heaters qualified to achieve the Phase I standard later in 2007.

### **NESCAUM's Model Rule**

On January 29, 2007, NESCAUM made available its "Outdoor Hydronic Heater Model Regulation." The model rule is designed to serve as a template to assist State and local agencies in adopting requirements that will reduce air pollution from outdoor wood-fired boilers. The model rule was developed in cooperation with a number of States and EPA. The model rule has provisions for:

- Critical definitions,
- Emission standards,
- Test method procedures,
- Certification process, and
- Labeling requirements.

The model rule contains a single method for regulating new units with respect to the critical elements and contemplates that States may propose alternative approaches for other provisions. It also provides alternatives for states to consider for regulating previously installed units (NESCAUM 2007).

NESCAUM's model rule sets standards for particulate matter (PM) emissions by phases for residential and commercial boilers. The PM standards for both boiler types are identical. Phase I calls for a PM emission limit of 0.44 pounds per million BTU heat input. This standard would have to be met by March 31, 2008. Phase II calls for a PM emission standard of 0.32 lb/MMBTU which is to be met by March 31, 2010.

### **Vermont's Rule on Outdoor Wood-fired Boilers**

On April 12, 2007 Vermont filed a regulation on outdoor wood-fired boilers with the Secretary of State and the Legislative Committee on Administrative Rules. The rule legally went into effect on April 27, 2007, and adopts NESCAUM's model rule Phase 1 PM emission standard of 0.44 lb/MMBTU. As of March 31, 2008, outdoor wood-fired boilers not meeting the standard of 0.44 lb/MMBTU cannot be sold in Vermont. Additional information on Vermont's final rule on outdoor wood-fired boilers can be found on the following web site: <http://www.vtwoodsmoke.org>. (Etter, personal communication)

This section of this document addresses the four factor analysis which includes the following elements: cost of compliance, time necessary for compliance, energy and non-air impacts, and remaining useful life of the source.

## **FOUR FACTOR ANALYSIS OF POTENTIAL CONTROL SCENARIOS FOR OUTDOOR WOOD-FIRED BOILERS**

### **Cost of Compliance**

Outdoor wood-fired boilers are priced according to their size (heat output). For example, Northwest Manufacturing sells a line of outdoor wood-fired boilers that ranges in price from \$4,295 for a boiler that will heat a 2,000 square foot house to \$12,995 for a boiler that can heat up to 20,000 square feet. Similarly, Hud-Son Forest Equipment has a line of outdoor wood-fired boilers that range in price from \$6,095 for boiler that can heat a 2,000 square foot house to \$7,795 for a boiler that can heat up to 10,000 square feet.

There are currently only a few outdoor wood-fired boiler manufacturers whose products would meet the 2008 NESCAUM phase I standard of 0.44 lb/MMBTU. NESCAUM estimates that there are "several units currently on the market that can meet this standard." In addition, NESCAUM estimates that more stringent air standards that it proposed should come into compliance in 2010 would currently only be met by one unit. Consequently, manufacturers of outdoor wood-fired boilers would have to invest money into research and development in order to manufacture boilers that would meet NESCAUM's model standards. MACTEC contacted an outdoor wood-fired boiler manufacturer to determine cost increases due to the NESCAUM rule. The boiler manufacturer was not able to provide estimated cost increases necessary to manufacture boilers meeting the NESCAUM model rule standards (personal communication with Central Boiler, Inc.).

MACTEC also investigated the costs of replacing the outdoor wood-fired boilers with heating oil-fired furnaces and boilers. We determined that the capital cost of oil-fired water boilers ranged from \$2,800 - \$3,825. Similarly, the capital cost of oil-fired furnaces range from \$1,560 -

\$1,800 (Alpine Home Air 2007). Therefore, oil-fired boilers and furnaces can be substantially less expensive than outdoor wood-fired boilers.

In a previous section, information was presented on the average amount of distillate fuel oil used on an annual basis by households in the Northeast. It was estimated that households use approximately 865 gal/yr of fuel oil (STAPPA-ALAPCO 2006). Therefore, the annual average heating cost using fuel would currently be approximately \$2,100 (assuming a fuel oil price of \$2.40/gal). The University of Wisconsin Solid and Hazardous Waste Education Center (2007) estimates that it would take only 4 full cords of oak firewood to heat a house per year. At approximately \$200/cord (Boston.com 2004), this equates to an annual fuel cost of \$800/year. Consequently, the annual cost for firewood is \$1,300 less than the cost of distillate fuel oil. Additionally, many operators of outdoor wood boilers have access to a free supply of firewood for the boiler, thus the only fuel cost to these operators is the time, effort, and expense associated with gathering the wood and cutting it for use in the outdoor wood-fired boiler.

Assuming the average household use of 865 gal/yr of fuel oil, and a fuel oil heating value of 140 MMBTU per thousand gallons, the annual heat input required is 121.1 MMBTU. The emission factors for residential fuel oil combustion, natural gas combustion, and wood combustion in outdoor wood-fired boilers are 0.003, 0.002, and 1.5 to 3.1 pounds of PM per MMBTU heat input respectively. Using the annual heat input requirement of 121.1 MMBTU, the annual emissions from an oil-fired furnace would be 0.4 pounds, the emissions from a natural gas-fired furnace would be 0.2 pounds, and the emissions from the outdoor wood-fired boiler would be from 180 to 380 pounds. The cost of replacing an outdoor wood-fired boiler with an oil-fired furnace or boiler is estimated to be from \$1,560 to \$3,825 (Alpine Home Air 2007). If the capital cost of the oil-fired furnace or boiler is spread over ten years, the annualized capital cost is between \$156 and \$383. Additionally, the cost of fuel oil is estimated to be from \$0 to \$2,100 more than the outdoor wood-fired boiler fuel costs depending on whether the operator has access to a free wood supply, or must purchase the wood by the cord. Based on these estimates, the PM cost effectiveness of replacing an outdoor wood-fired boiler with an oil-fired furnace or boiler would be from \$1,700 to \$13,000 per ton of PM reduced. The costs for replacement of outdoor wood-fired boilers with natural gas-fired furnaces or boilers have not been quantified.

### **Time Necessary for Compliance**

Outdoor wood-fired boilers have been in operation for approximately the last 15 years (personal communication with P. Etter from Vermont Air Pollution Control). Consequently, the average age of outdoor wood-fired boilers is not known. On at least one occasion, a boiler vendor opted to go out of business rather than honor 5-year warranties (personal communication with J. Gulland from OutdoorHeat.org). If States pass a rule similar to NESCAUM's and existing boilers are grandfathered, only new boilers would be required to meet the more stringent standards. In the section on residential heating, it was estimated that the average useful life of a residential boiler is between 18-25 years. Well manufactured outdoor wood-fired boilers may have similar useful lives. Therefore, new boilers meeting more stringent PM emissions standards would be phased in slowly as older boilers are replaced.

Replacement of wood-fired boilers with oil-fired furnaces or boilers could occur on a very quick schedule. The number of residential boiler/furnace manufacturers in the United States is

indicative of the fact that there is an ample supply of manufacturers. Although it is possible for outdoor wood-fired boilers to be replaced quickly, realistically, most of these units have been installed within the past 15 years. Since they are designed to last for approximately 20 years, operators of the outdoor wood-fired boilers would likely be reluctant to replace them immediately.

### **Energy and Non-Air Impacts**

Wood is a renewable resource that is plentiful in the United States Northeast. The increased use of outdoor wood-fired boilers would lead to an increase in the amount of firewood that is combusted in the US Northeast on an annual basis. Alternatively, tighter rules regarding the PM emissions from outdoor wood-fired boilers may lead to a decrease in their use, which would make more firewood available for use in wood stoves and fire places. A move away from wood-fired boilers would increase the demand on heating fuels such as heating oil, propane, and potentially coal or natural gas.

The increased use of outdoor wood-fired boilers may have a variety of non-air impacts on the environment, especially on forest and water resources. The potential impacts are outlined below.

**Nuisance Smoke:** Outdoor wood-fired boilers typically have very short stacks, and are prone to smoke. The short stacks oftentimes prevent proper mixing of the smoke and soot with the surrounding air, thereby creating nuisance smoke problems for surrounding houses or communities (Michigan DEQ 2007).

**Water:** Increased logging to satisfy the demand for firewood may increase runoff of silts and sediments into adjacent creeks and rivers. This increased sediment load in rivers can affect aquatic ecosystems that are integral to rivers and streams.

**Soils:** Increased logging may impact soils in many ways. For example, heavy machinery used to fell and process trees may lead to rutting and compaction of the soil, which in turn leads to higher erosion and/or altered vegetative regrowth.

**Wildlife:** Increased logging may put pressure on existing wildlife populations in the US Northeast by altering their critical habitat.

**Threatened and Endangered Species:** Increased logging in Northeast may impact threatened and endangered species through habitat destruction or alteration.

### **Remaining Useful Life of the Source**

The useful life of outdoor wood-fired boilers is approximately 20 years, which is also very close to the useful life of other residential boilers (Etter, personal communication). In addition, Mr. Etter indicated that outdoor wood-fired boilers have only been around for approximately 15 years, therefore, most of the boilers that have been put into service are likely to remain there for at least the next five years.

## REFERENCES

- EPA, 1998a. *Emissions from Outdoor Wood-Burning Residential Hot Water Furnaces*. EPA Publication Number EPA-600/R-98-017.
- EPA, 1998b. AP-42 section 1.3. *Fuel Oil Combustion*.
- EPA, 1998c. AP-42 section 1.4. *Natural Gas Combustion*.
- Etter, P., Vermont Department of Environmental Conservation, Air Pollution Control Division. Personal communication with Mr. Bernd Haneke, MACTEC Federal Programs, Inc., on March 9, 2007.
- Etter, P., Vermont Department of Environmental Conservation, Air Pollution Control Division. Personal communication with Mr. William Hodan, MACTEC Federal Programs, Inc., on July 3, 2007.
- Gulland, J., OutdoorHeat.org. Personal communication with Mr. Bernd Haneke, MACTEC Federal Programs, Inc., via E-mail on March 9, 2007.
- Guldberg, P., Tech Environmental, Inc. Personal communication with Mr. William Hodan, MACTEC Federal Programs, Inc. via E-mail on May 17, 2007.
- Guldberg, P. 2007. *Outdoor Wood Boilers – New Emissions Test Data and Future Trends*. Presented at the 16th Annual International Emission Inventory Conference - Emission Inventories: “Integration, Analysis, and Communications”
- Killeen, W. 2004. *Firewood Shortage Reflected in Prices*. Document obtained from the World Wide Web at: [www.boston.com](http://www.boston.com)
- Michigan Department of Environmental Quality 2007. *Outdoor Wood Boiler and Air Quality Factsheet*. Document obtained from the World Wide Web at: [www.michigan.gov/deqair](http://www.michigan.gov/deqair)
- NESCAUM, 2006. *Assessment of Outdoor Wood-fired Boilers*. Document obtained from the World Wide Web at: <http://burningissues.org/outdoor-wood-boilers.htm>
- NESCAUM, 2007. *Outdoor Hydronic Heater Model Regulation*. Document obtained from the World Wide Web at: <http://burningissues.org/outdoor-wood-boilers.htm>
- NESCAUM. Personal communication between Ms. Lisa Rector and Dr. Art Werner, MACTEC Federal Programs, Inc., on June 6, 2007.
- STAPPA ALAPCO, 2006. *Controlling Fine Particulate Matter Under the Clean Air Act: A Menu of Options*.
- Central Boiler, Inc. Personal communication between Mr. Rodney Tollefson and Mr. Bernd Haneke, MACTEC Federal Programs, Inc., on March 8, 2007.



University of Wisconsin 2005. *Using Wood as a Residential Heating Fuel: Issues and Options*.  
Published by the University of Wisconsin Solid and Hazardous Waste Education Center, and  
downloaded from the World Wide Web at:  
[uwm.edu/Dept/shwec/publications/cabinet/p2/outdoorwoodfiredboilers.pdf](http://uwm.edu/Dept/shwec/publications/cabinet/p2/outdoorwoodfiredboilers.pdf)

Information on prices of furnaces and boilers were obtained from the World Wide Web using the  
following URLs: [www.alpinehomeair.com](http://www.alpinehomeair.com); [www.hud-son.com/woodfurnaces.htm](http://www.hud-son.com/woodfurnaces.htm);  
[www.woodmaster.com/web.htm](http://www.woodmaster.com/web.htm)

